

DPV-541

Operator's Manual



DASCUM Europe GmbH
Heuweg 3
D-89-079 Ulm
Germany
+49 (0) 731 2075 0
www.dascomeurope.de

www.dascom.com



This device fulfills the European standards requirements by complying with the Directive relating to electromagnetic compatibility and relating to low-voltage electrical equipment. Furthermore it fulfills the requirements for RoHS and R&TTE if applicable.

Conformity with the above mentioned Directives is indicated by the CE symbol attached to the device.

Note: Conformity may be affected by:

- using interface cables not complying with the specifications
- non-observance of important instructions in the operator's manual
- installing components not approved for this device by the manufacturer
- unauthorized manipulation



Dieses Gerät erfüllt die Anforderungen der Europäischen Normen durch Einhaltung der Richtlinien bezüglich der Elektromagnetischen Verträglichkeit sowie bezüglich Elektrischer Betriebsmittel mit Niederspannung. Des Weiteren werden die Anforderungen bezüglich RoHS und falls anwendbar R&TTE erfüllt.

Die Konformität zu den oben angeführten Richtlinien ist durch das am Gerät angebrachte CE-Zeichen gekennzeichnet.

Hinweis: Die Konformität kann beeinflusst werden durch:

- Benutzung von nicht spezifizierten Schnittstellen
- Nichtbeachtung wichtiger Hinweise der Bedienungsanleitung
- Ersetzen von Bauteilen, die nicht vom Hersteller für dieses Gerät freigegeben wurden
- Eingriffe durch Unbefugte

FCC Part 15 Class B

This device complies with Part 15 of the FCC Rules. Operation is subject to the following two conditions: (1) this device may not cause harmful interference, and (2) this device must accept any interference received, including interference that may cause undesired operation.

This equipment has been tested and found to comply with the limits for a Class B digital device, pursuant to Part 15 of the FCC rules. These limits are designed to provide reasonable protection against harmful interference in a residential installation. This equipment generates, uses and can radiate radio frequency energy and, if not installed and used in accordance with the instructions, may cause harmful interference to radio communications. However, there is no guarantee that interference will not occur in a particular installation. If this equipment does cause harmful interference to radio or television reception, which can be determined by turning the equipment off and on, the user is encouraged to try to correct the interference by one or more of the following measures:

- Reorient or relocate the receiving antenna.
- Increase the separation between the equipment and the receiver.
- Connect the equipment into an outlet on a circuit different from that to which the receiver is connected.
- Consult the dealer or an experienced radio/TV technician for help.

This equipment complies with Canadian and FCC radiation exposure limits set forth for an uncontrolled environment. This equipment is in direct contact with the body of the user under normal operating conditions. This transmitter must not be co-located or operating in conjunction with any other antenna or transmitter.

Part 15.21 Caution: Changes or modifications not expressly approved by Dascom could void the user's authority to operate the equipment.

Bluetooth Equipped Models:

For units equipped with a Dascom Bluetooth module, reference FCC ID: Bxx-xxxxxxxxx.

Acknowledgments:

Bluetooth is a registered trademark of Bluetooth SIG, Inc.
Zebra, CPCL and ZPL are registered trademarks of Zebra Technologies

Wi-Fi is a registered trademark of the Wi-Fi Alliance
Windows is a registered trademark of Microsoft Corporation
All other trademarks are the property of their respective owners.



Read all set up and operating instructions before proceeding with operation. Do not operate in an enclosure unless properly ventilated. Do not operate near a heat source.



Lesen Sie vor der Inbetriebnahme die Aufbau- und Bedienungsanleitung. Betreiben Sie den Drucker nicht in einem kleinen, geschlossenen Raum, es sei denn dieser wird ordnungsgemäß belüftet. Nehmen Sie den Drucker nicht in der Nähe einer Wärmequelle in Betrieb.



No user-serviceable parts inside. Refer service or repairs to a qualified service professional. Use of genuine Dascom replacement parts is required to warrant proper, safe operation. Any alteration or modification of this device voids the user warranty and may make the product unsafe to operate. The print head and motors get hot during use. Wait until they cool before touching them. Make certain the printer is disconnected from AC power before removing any covers or performing any required cleaning or maintenance. Connecting this printer to an ungrounded receptacle can result in electrical shock. Never place the printer near inflammable or explosive substances. Do not operate near liquid or spill liquid into the printer at any time.



Enthält keine Teile, die vom Bediener instandgesetzt werden können. Bitte wenden Sie sich bei Instandsetzung oder Reparatur an qualifiziertes Kundendienstpersonal. Die Verwendung von Original Dascom Ersatzteilen ist notwendig, um ordnungsgemäßen, sicheren Betrieb zu gewährleisten. Änderungen oder Modifikationen dieses Geräts machen die Garantie ungültig und können den sicheren Betrieb des Produkts gefährden. Während des Druckens werden Druckerkopf und Motoren heiß. Warten Sie, bis sich die Teile abgekühlt haben, bevor Sie sie berühren. Vergewissern Sie sich, dass der Drucker nicht mehr an die Stromquelle angeschlossen ist, bevor Sie Abdeckungen abnehmen oder das Gerät reinigen bzw. warten. Schließen Sie diesen Drucker nicht an eine ungeerdete Steckdose an; dies kann zum Elektroschock führen. Setzen Sie den Drucker niemals in die Nähe von feuer- oder explosionsgefährlichen Stoffen. Betreiben Sie den Drucker nicht in der Nähe von Flüssigkeiten und lassen Sie keine Flüssigkeiten in den Drucker gelangen.

Specifications are subject to change without notice.

DASCOM Representatives:

Germany :	DASCOM Europe GmbH, Heuweg 3, D-89079 Ulm, Phone: +49 (0) 731 2075 0
UK:	DASCOM GB Ltd, Hart House, Priestley Road, Basingstoke, Hampshire, RG24 9PU, Phone: +44 (0) 1256 481481
France:	DASCOM Europe GmbH, 117 Avenue Victor Hugo 92100 Boulogne-Billancourt, Phone: +33 (1)73 02 51 98
Singapore (AP):	DASCOM AP Pte Ltd, 21 Bukit Batok Crescent, #29-81, WCEGA Tower, 658065, Phone: +65 6760 8833
Americas:	Dascom Americas Corp, 34 Lakeview Court, Verona, VA 24482, USA, Phone: +1 (877) 434 1377
China:	Jiangmen Dascom Computer Peripherals Co., Ltd, No.399, jinxing Road, Jianghai District Jiangmen

TABLE OF CONTENTS

Introduction	2
Printer Features	3
Quick Start Instructions.....	4
A. Paper Load.....	4
B. Cable Installation.....	5
C. Printer Installation.....	6
D. Status Indications – Patterns & Meanings.....	7
E. Performing a Printer Self-Test.....	7
Integrating the Printer into your Business Applications Step by Step – Creating a Link from Host to Printer.....	8
Print Drivers.....	8
A. Windows Laptop/Desktop.....	8
I. USB	8
II. Bluetooth.....	8
B. Android Tablets and Smartphones.....	8
I. Bluetooth.....	8
C. Apple Tablets and Smartphones	9
D. Windows Tablets and Smartphones.....	9
Bluetooth	9
Configuration	10
A. Connectivity Parameters	11
B. Image Config.....	16
C. Device Config	18
D. Fonts	20
E. Graphics.....	20
F. Update Printer Firmware, Upload Files to Printer Memory	22
G. Reset Printer Configuration to Factory Defaults (Safe Mode)	22
Media.....	23
A. Standard Media.....	23
B. Black Mark Media Position	23
Maintenance and Troubleshooting.....	24
A. Cleaning	24
B. Troubleshooting.....	24
I. Error Conditions	24
II. Other Problems.....	25
C. Obtaining Service	26
APPENDIX.....	27
A. Appendix A – Tally Dascom DPV-541 Printer Specifications	27
Glossary of Terms	28
Index.....	30

Introduction

Thank you for purchasing a Tally Dascom DPV-541 Model Series thermal printer for integral in-vehicle application. Each printer is shipped with a Quick Start Guide, and one roll of receipt paper.

The DPV-541 series offers a variety of configurations to suit any printing environment. The DPV-541 Model prints on receipt paper supplied in roll form up to 4.125 inches wide and includes “black mark” sensing capabilities on the printed side of the media. Standard interface is USB. All models also support an optional internal Bluetooth or WI-FI interface. Complete specifications may be found in [Appendix A – Printer Specifications](#).

Please visit www.dascom.com to download latest printer drivers and manuals.

The remainder of this manual focuses on preparing the printer for initial use and tasks that will be encountered during everyday use. Maintenance and Troubleshooting describes how to maintain the printer for optimal performance and has information on how to diagnose any problems that may occur.

Dascom recommends using genuine Dascom supplied media and accessories.

Printer Features

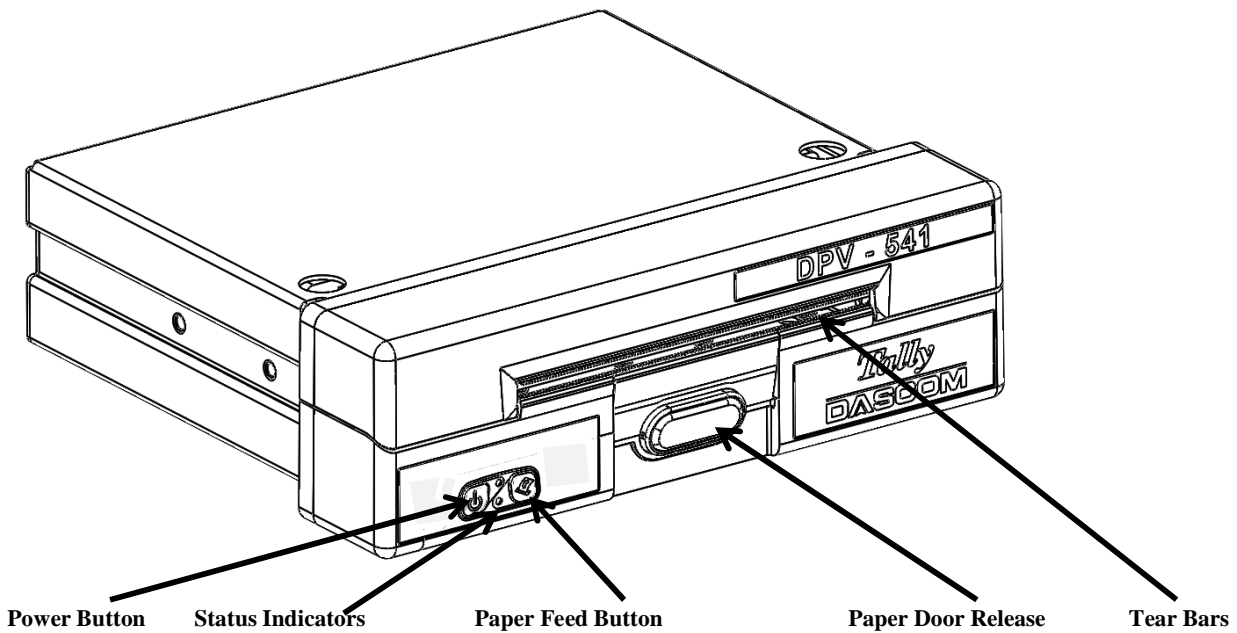

Your DPV-541 features:

- Easy-to-read control face and simple drop-in paper loading
- Quickly prints a wide variety of tickets, and receipts
- IP54 rated for water and dust resistance
- Extensive fonts, character sets, barcodes, and graphic capabilities
- Compatible with Windows, WindowsMobile, Android
- Emulations that allow the printer to be a drop-in replacement for nearly any mobile printer

For detailed specifications reference [Appendix A – Printer Specifications](#).

Quick Start Instructions

A. Paper Load

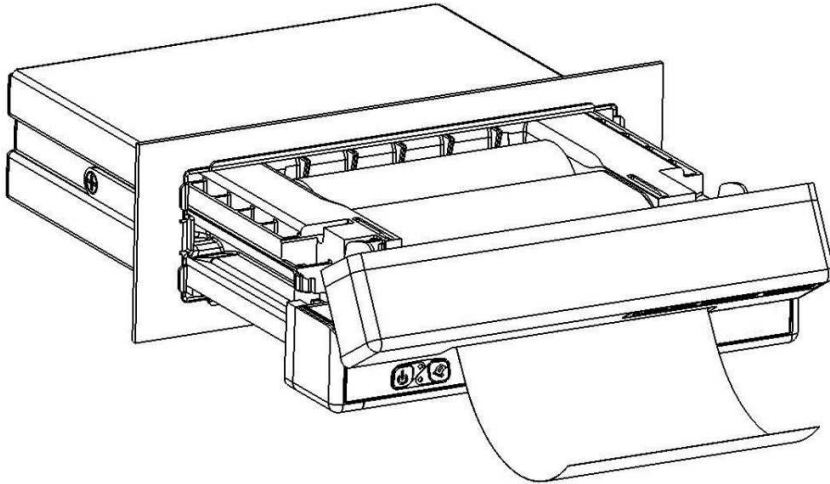

Push paper door release, pull out drawer, drop in paper roll and route through door as shown.

Printouts can be torn off in either direction.

B. Cable Installation

Dascom provides a single 9-pin D-connector that plugs into the back of the DPV-541 printer. This connection provides for both data communication and power to the printer. The cable has a USB-A connection to plug into the host. The cable has two unterminated power wires coming out of the connector. The positive cable is marked with red.

The Red labeled wire in the power cable may be connected to a 9-32 VDC source and the Black wire is to be connected to vehicle ground. The printer's power input is internally fused, but may be connected to a fused circuit that is capable of providing at least 5A.

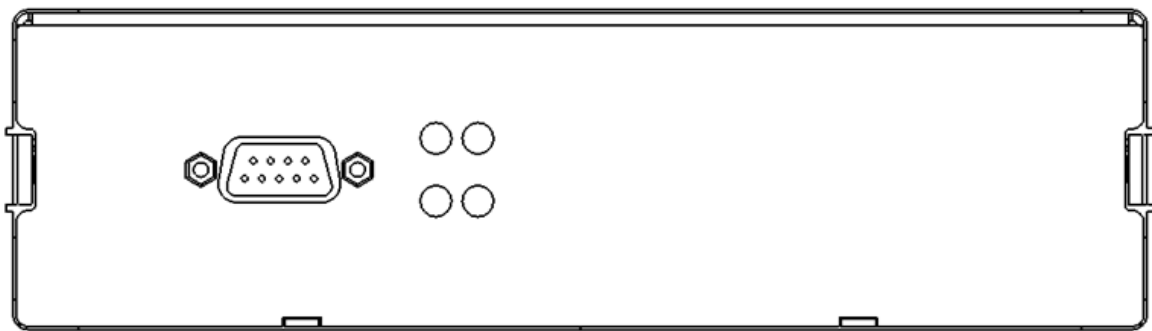

Data/Power Connector Pin Assignments

Pin	Description
1	USB Ground
2	D-
3	D+
4	USB +5V
5	Power Ground
6	USB Shield*
7	NC
8	Power (9-32 VDC)
9	NC

*Note: Do not use USB Shield as power ground.

C. Printer Installation

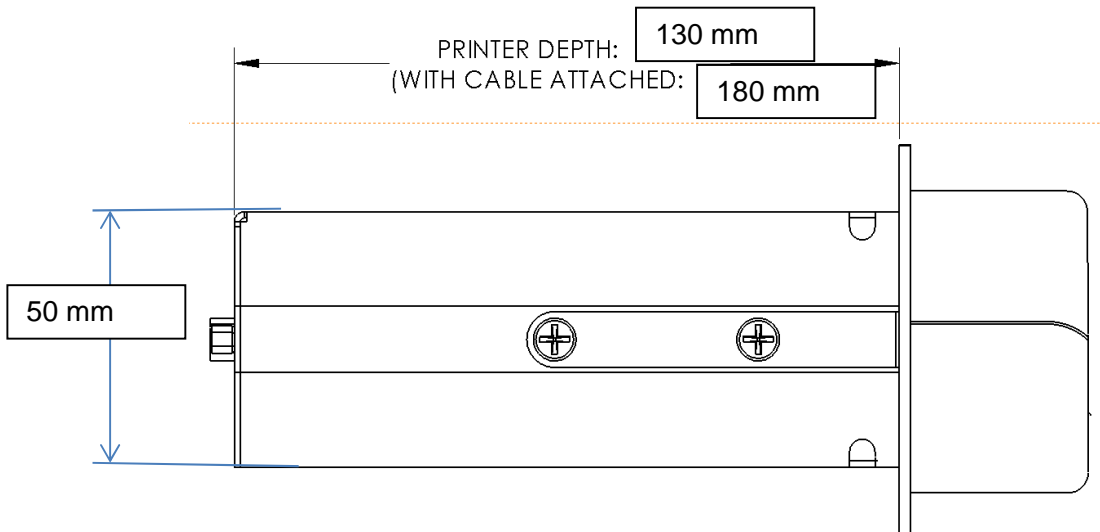

To complete the installation, secure the data/power cable connector to the back of the printer, insert the printer into the dash/console.

D. Status Indications – Patterns & Meanings

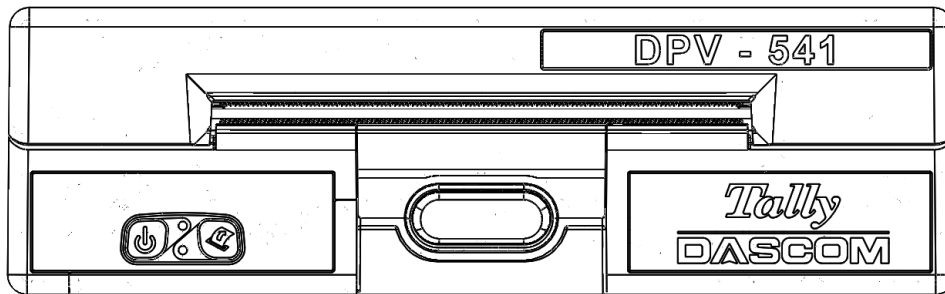

○		Printer is Off.
●	Green	Printer is On.
☀	Green	Printer is receiving data and/or printing, or is in Setup mode.
☀	RED	Paper out, Paper Door is open, or printer is in set up mode.

○ = Off ● = On ☀ = Flashing

E. Performing a Printer Self-Test

To print configuration page and conduct printer self-test, with power on, double click the paper feed button.

Integrating the Printer into your Business Applications

Step by Step – Creating a Link from Host to Printer

Print Drivers

Printer drivers can be downloaded from our web site: www.dascom.com
... under Support / Download Center

Select the DPV-541 driver. This driver will work for both 32 and 64 bit operating systems.

The drivers are downloaded as .zip files. Unzip the file into a folder. For best results do not unzip the files to your desktop.

Run the DriverSetup.exe program to install the Windows driver.

A. Windows Laptop/Desktop

I. USB

- a) When connected through the USB cable the driver will recognize the printer and assign the proper port during driver installation.

II. Bluetooth

- a) Using the Bluetooth Manager on your PC, the printer discover name will be DPV-XXXxxxxx (XXXxxxxx is the serial number of the printer).
- b) The default passkey is 0000 (4 zeros).
- c) The Bluetooth Manager will assign a virtual com port number to the connection. Make note of the COM port number
- d) You will need to use this COM port number when installing the Windows printer driver.
- e) Use the Manual installation option and select the COM port number assigned by the Bluetooth manager.

B. Android Tablets and Smartphones

I. Bluetooth

- a) Using the Bluetooth Manager on your Android device, scan for available Bluetooth devices.
- b) The printer discover name will be DPV- XXXxxxxx (XXXxxxxx is the serial number of the printer).
- c) The default passkey is 0000 (four zeros).

NOTE: The device will pair to the printer but does not connect until a print job is sent to the printer.

C. Apple Tablets and Smartphones

This feature and/or specific directions for use were not available as of this printing.

D. Windows Tablets and Smartphones

Bluetooth

- a) Using the Bluetooth Manager on your PC, the printer discover name will be DPV-XXXXXXX (XXXXXXX is the serial number of the printer).
- b) The default passkey is 0000(four zeros).
- c) The Bluetooth Manager will assign a virtual com port number to the connection. Use this COM port number in application when printing to the printer.

Configuration

Configuration of the DPV-541 printer is done through a built-in web page. This allows you to configure the printer from any device that has a browser and is compatible with your DPV-541 communication capabilities.

1. Turn the printer ON.
2. Connect a USB cable between the printer and a PC.
3. To access the DPV-541 web page, push the Power button twice rapidly. This will put the printer into Configuration mode.
4. When the printer is in Configuration mode the POWER and FAULT LEDs will flash together.
 - a. Open browser on your PC and type **169.254.200.1** into the address bar of the browser and hit Enter - A login box should appear:

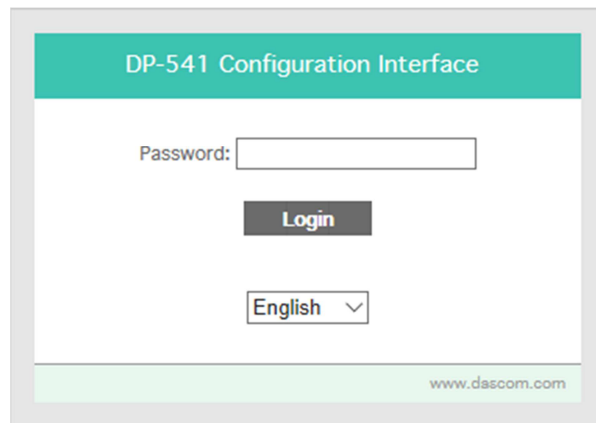

The image shows a screenshot of the DP-541 Configuration Interface. The page has a teal header with the text "DP-541 Configuration Interface". Below the header, there is a "Password:" label followed by a text input field. Underneath the input field is a dark grey "Login" button. Below the button is a language selection dropdown menu currently set to "English". At the bottom right of the page, the URL "www.dascom.com" is displayed.

- b. Type "0000" and hit Enter- you should now be at the home page for DPV-541 Configuration.

5. The main configuration screen of the DPV-541:

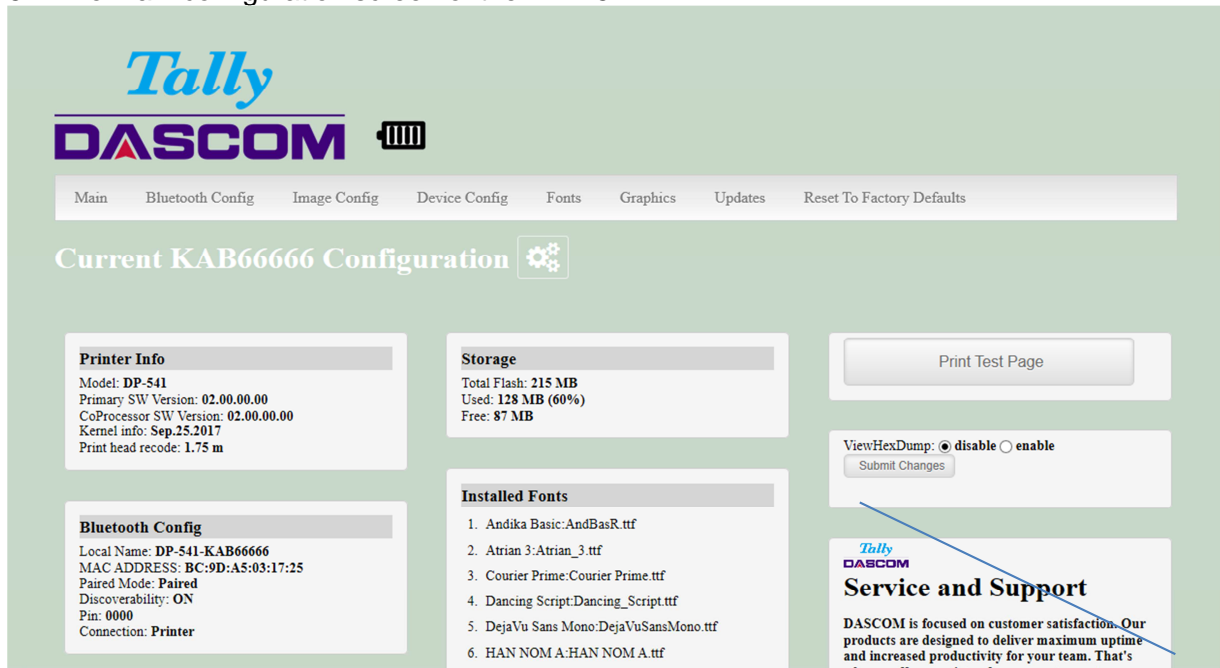

This is an overview of the printer configuration.

To return the printer to normal operating mode, double-click the Power button. The POWER LED will be returned to a solid light.

At the top of the Main Page are selections to access the sub-menus.

A. Connectivity Parameters

This page allows you to setup the connection to your printer. Depending on the optional interface installed, you will see either Bluetooth Config or WI-FI Config. In the detailed descriptions, an asterisk (*) indicates the factory default value.

Bluetooth Config:

The screenshot shows the 'Bluetooth Config' page of the Tally DASCOM printer's web interface. At the top, there is a navigation menu with links for 'Main', 'Bluetooth Config', 'Image Config', 'Device Config', 'Fonts', 'Graphics', and 'Updates'. Below the menu is a 'Reset To Factory Defaults' link. The main heading is 'Bluetooth Config' with a gear icon. The configuration area contains the following fields and options:

- Local Name:** A text input field containing 'DP-541-KAB66666'.
- MAC ADDRESS:** A text field displaying 'BC:9D:A5:03:17:25'.
- Paired Mode:** Radio buttons for 'UnPaired' and 'Paired', with 'Paired' selected.
- Discoverability:** Radio buttons for 'Off' and 'On', with 'On' selected.
- Pin:** A text input field containing '0000'.

Paired Mode:

Possible values: UnPaired, Paired*

This feature allows Bluetooth pairing to occur between the printer and the connecting device whenever Pairing is required by either device. Pairing requires that the PIN on the printer and the connecting device exactly match each other.

Discoverability:

Possible Values: Off, On*

This feature is used to set whether the printer may be discovered by other Bluetooth devices. It should only be set to "Off" after the printer has been discovered and paired with a host computer.

PIN:

Possible Values: 0000*, Up to 16 Numeric Characters.

Note that this feature is only available if Pairing Mode is set to "Paired". The PIN value must exactly match the PIN value set in the Bluetooth manager on the host computer.

Connection:

Possible Values: Printer*, Personal Area Network

This feature selects the role of the printer's interface in the Bluetooth network.

In Printer mode, the printer behaves as a regular Bluetooth device.

In Personal Area Network mode, the printer behaves similar to a Wi-Fi access point. The Power LED will flash off every two seconds while in this mode. After pairing with the printer, the host Bluetooth icon will appear different, indicating that an access point is present.



Some hosts require an extra connect step after pairing. After connecting, the printer will issue an IP address to the host and the host can communicate to the printer as if it were a Wi-Fi printer. The printer's address to the host is always **169.254.200.1**.

In the host device's browser (if equipped) this address may be entered in the address bar to access the printer web page.

WI-FI Config:

The screenshot shows the printer's web interface. At the top, there is a navigation menu with links: Main, WIFI Config, Image Config, Device Config, Fonts, Graphics, Updates, and Reset To Factory Defaults. The main content area is titled "Wireless Configuration" and contains a form with the following fields:

- Address Method:** Radio buttons for Static, DHCP (selected), and Access Point.
- Wifi Port:** A text input field containing the value "8023".

Below the form are two buttons: "Submit Changes" and "Discard Changes".

Below the form is a section titled "Current Connection" with a signal strength indicator. It shows a table with one row:

Network ID
wpa_state

Below the table are two buttons: "show details" and "hide details".

At the bottom, there is a section titled "Previously Connected Networks" with a signal strength indicator. It shows a table with the following columns:

Network ID	SSID	BSSID	Status	Connect/Disconnect	Remove
------------	------	-------	--------	--------------------	--------

Wireless Configuration

This will display the current Wi-Fi configuration:

IP Address – user defined. If Static Address Method is selected, type in the address the printer will use on the network.

SubNetMask – user defined. If Static Address Method is selected, type in the subnet mark of the network.

Gateway – user defined. If Static Address Method is selected, type in the gateway address of the network.

SSID – user defined. Network name broadcasted by printer when set to Access Point mode.

Passphrase – user defined. Password used to access the printer in Access Point mode

WiFi Port – user defined. Type in the IP port to be used by the printer. (default value = 8023)

Address Method – user selectable

Static – printer will always connect to the network using the IP address defined.

DHCP – printer will acquire an IP address from your network DHCP server

Access Point –The printer will broadcast itself as a network connection. The Power LED will flash off every two seconds while in this mode. The SSID will be the serial number of the printer.

When connecting to the printer, the passphrase is DASCOM123.

Access Point mode can also be activated outside of the printer web page.

To enter Personal Area Network mode, press and hold the Power and Paper Feed buttons until the Power and Alert LEDs light. Release both buttons, and the printer will restart in Personal Area Network mode. To exit Personal Area Network mode, press and hold the Power and Paper Feed buttons until the Power and Alert LEDs light. Release both buttons, and the printer will restart in normal Wi-Fi mode.

Current Connection

wpa_state
SCANNING

Previously Connected Networks

Network ID	SSID	BSSID	Status	Connect/Disconnect	Remove

Available Networks

BSSID	Frequency	Signal Level	Flags	SSID	Add/Connect
10:be:f5:19:83:3c	2462	204	[WPA-PSK-TKIP+CCMP][WPA2-PSK-TKIP+CCMP][WPS][ESS]	Printek3	<input type="button" value="Add/Connect"/>
e4:6f:13:45:18:00	2437	198	[WPA-PSK-TKIP+CCMP][WPA2-PSK-TKIP+CCMP][WPS][ESS]	Printek2	<input type="button" value="Add/Connect"/>
8c:0f:6f:55:b7:28	2462	191	[WPA-PSK-TKIP+CCMP][WPA2-PSK-TKIP+CCMP][WPS][ESS]	CBCI-D25A-2.4	<input type="button" value="Add/Connect"/>
10:05:01:2e:43:00	2462	176	[WPA-PSK-TKIP+CCMP][WPA2-PSK-TKIP+CCMP][WPS][ESS]	CBCI-8F7D-2.4	<input type="button" value="Add/Connect"/>
e0:c1:c0:75:e1:22	2412	208	[WPS][ESS]	tsupport	<input type="button" value="Add/Connect"/>
f2:d6:93:b7:9a:bc	2462	197	[IBSS]	SETUP	<input type="button" value="Add/Connect"/>
a0:f3:c1:ab:de:a2	2437	185	[WPS][ESS]	Testing	<input type="button" value="Add/Connect"/>

Current Connection – access points added through Add/Edit.

Previously Connected Networks – access points detected by the printer or added through Add/Edit Network will be displayed. Select Connect to use one of these access points, or Remove to delete it from printer.

Available Networks – access points detected by the printer will be displayed. Select Add/Connect to use one of these access points.

The screenshot shows a web-based configuration interface for a printer's network settings. It is divided into three main panels: 'Add Personal Network', 'Add Enterprise Network', and 'Upload Digital Certificate'.
1. **Add Personal Network:** Contains a 'Submit' button at the top, followed by 'SSID' and 'Password' text input fields. Below these is an 'Authentication' dropdown menu with options: 'No Authentication', 'WPA-Personal(PSK)', 'WPA2-Personal(PSK)', and 'Static WEP(no authentication)'. Underneath is an 'Encryption' dropdown menu with 'TKIP' selected, and a 'Submit' button at the bottom.
2. **Add Enterprise Network:** Contains a 'Submit' button at the top, followed by 'SSID' and 'Password' text input fields. Below these is an 'Authentication' dropdown menu with options: 'Static WEP(Shared Key)', 'IEEE 802.1X', 'WPA-Enterprise(EAP)', and 'WPA2-Enterprise(EAP)'. Underneath is an 'Encryption' dropdown menu with 'TKIP' selected, an 'Identity' text input field, and a 'Submit' button at the bottom.
3. **Upload Digital Certificate:** Features a 'Filename:' label, a text input field, a 'Browse...' button, and an 'Upload' button.
At the bottom of the interface is the **Add/Edit Network** section, which includes a 'Key Management Protocol' dropdown menu, a 'Network Name' text input field, and a 'Next' button.

Add Personal Network and Add Enterprise Network

Enter the SSID of a network connection. If authentication is used select the authentication type. Click Next.

The following form will change depending on the authentication type:

WPA-PSK

Enter the password for the network connection.

WPA-EAP or IEEE8021X

These are Enterprise network settings. Consult your server manual for recommended settings.

Upload Digital Certificate

If your enterprise network uses digital certificates as another form of authentication, you can upload the certificates here.

B. Image Config

This page allows you to make selections about the image to be printed.

Encoding	<input checked="" type="radio"/> GB18030 <input type="radio"/> UNICODE <input type="radio"/> UTF-8
Current Emulation	ESCPOS <input type="button" value="v"/>
Font Type	Font A <input type="button" value="v"/> Font A: 12*24 Font B: 9*17
Letter Shape	Art Style <input type="button" value="v"/>
Digit Shape	Normal <input type="button" value="v"/>
Chinese Font Type	Font A <input type="button" value="v"/> Font A: 24*24 Font B: 32*32
Character Type	Chinese Character Set <input type="button" value="v"/>
Default Line Spacing	30 Unit:point

Current Emulation:

Possible Values: ESCPOS*, PRINTEK, ZPL, CPCL, AUTOIMAGE, PDF, POSTSCRIPT, IMAGE

The DPV-541 printer is capable of using several different emulation modes. This feature sets the family of printer commands that may be used by a host application program to control the various capabilities of the printer. The printer will only respond to commands valid for the currently selected emulation. For more information, please refer to the *Integrator's Guide*.

Besides the popular printer languages to choose from, the following selections allow the DPV-541 to print many other file formats directly, without the need for a driver.

AUTOIMAGE – selected when mixed PDF and POSTSCRIPT images are sent to the printer. The printer will determine which type of file has been sent. This can increase printer response time.

PDF – When in this mode the printer will directly print Portable Document Files (PDF).

POSTSCRIPT – When in this mode the printer will directly print Postscript formatted files (.ps). You can also use a generic Postscript driver to print when in this mode.

IMAGE – selected if just image files are being sent to the printer. When in this mode the printer will directly print the following file types: .png, .jpg, .bmp, .pbm, .svg, .tiff

Default Font:

The DPV-541 has the ability to use True Type Fonts. All True Type Fonts loaded into printer memory are listed here. When using emulations that do not specify the font for each line of text, select the font you would like to use as the default font. All print jobs will use the default font unless a command is sent to the printer to use another font.

Chars Per Inch and Default Text Line Spacing:

NOTE: These settings only function in Printek Emulation

This determines how large the characters are and how many characters will print in a one inch space. The higher the number, the greater the number of lines per vertical inch of print.

C. Device Config

This page allows you to set certain hardware parameters on the printer.

Device Config

Form

Units	<input type="text" value="mm"/>
Max Paper Speed	<input type="text" value="127.0"/> mm per sec.
Mark Seek	<input checked="" type="radio"/> RollPaper <input type="radio"/> Front <input type="radio"/> Rear <input type="radio"/> Gap
Paper Sensor Threshold	<input type="text" value="40"/> % range 0-100%
Backup Distance Before Printing	<input type="text" value="0"/> mm
Feed Distance After Printing	<input type="text" value="0"/> mm
Left Margin	<input type="text" value="0"/> mm
Contrast	<input type="text" value="5"/> 1 - 10
Power Sleep	<input type="text" value="60"/> min(s)

Paper Sensitivity

Thermal paper settings: Locked <input type="button" value="lock"/> <input type="button" value="unlock"/>	Thermal paper type: <input type="text" value="8"/>
---	--

Units

Select between inches or millimeters. If you change units, do so before entering other settings.

Max Paper Speed

Possible values: 1.0 to 5.0 ips, Default = 5.0

When using labels or heavy paper stock, you may need to decrease the paper speed to prevent paper jams.

Mark Seeking

Possible values: Off*, Front.

Set the value when using regular or label media with black alignment. Depending on the value selected here you may or may not see some of the sensor threshold settings listed below.

NOTE: Before adjusting black mark gap thresholds set the Mark Width to match the width of the black mark or label gap on your media.

Paper Sensor Threshold

When using paper with a black on the front adjust this setting to insure the paper stops at the black mark. Normal value is between 70-90 %.

Backup Distance Before Printing

Used with Mark Seek. User defined. This is the distance the printer will pull in the paper before starting to print.

Stop Distance after Mark

Use with Mark Seeking. User defined. This is the distance the printer will advance the paper after the mark is detected.

Left Margin

Setting this value will tell the printer how far from the left edge of the paper to start the print job.

Contrast

Possible values 0 – 10. Default value is 5

The lower the value the lighter the print. The higher the value the darker the print.

Power Sleep

Possible values: Disabled*, 10, 30, 60, 120, 180 minutes.

Set this value to have the printer power off after a specified tie of inactivity.

Paper Energy Values

This is a locked value. These are preset configurations for different thermal paper grades. Higher numbers will produce darker printing.

D. Fonts

Font Family Name	Index	Indicator(System default fonts, which cannot be removed.)
Andika Basic	A	*
Courier Prime	B	*
Liberation Mono	C	*
MICR	D	*
Instruction	E	*
Liberation Sans	F	*
OCRA	G	*
HAN NOMA	H	*
Liberation Serif	I	*
VCR OSD Mono	J	*
Dancing Script	K	*
DejaVu Sans Mono	L	
Atrian 3	M	*
OCR B Std	N	*

Upload Font File

TrueType Fonts (.ttf, .otf, .tfc and .bdf) can be uploaded here.

Languages like ZPL and CPCL can use the fonts by referring to them by their Font Family Name.

Printek emulation uses the Index value when selecting a font.

Font Aliases

Languages like ZPL and CPCL can use an uploaded Font Alias Table so legacy jobs can have their font names mapped to other uploaded fonts. Contact Technical Support of your Dascom Representatives for more information.

E. Graphics

This menu will allow you to load a graphics file into printer memory for use in creating your output. For instance, logos can be stored for recall and use by your host program (see *Integrator's Guide* for more details).

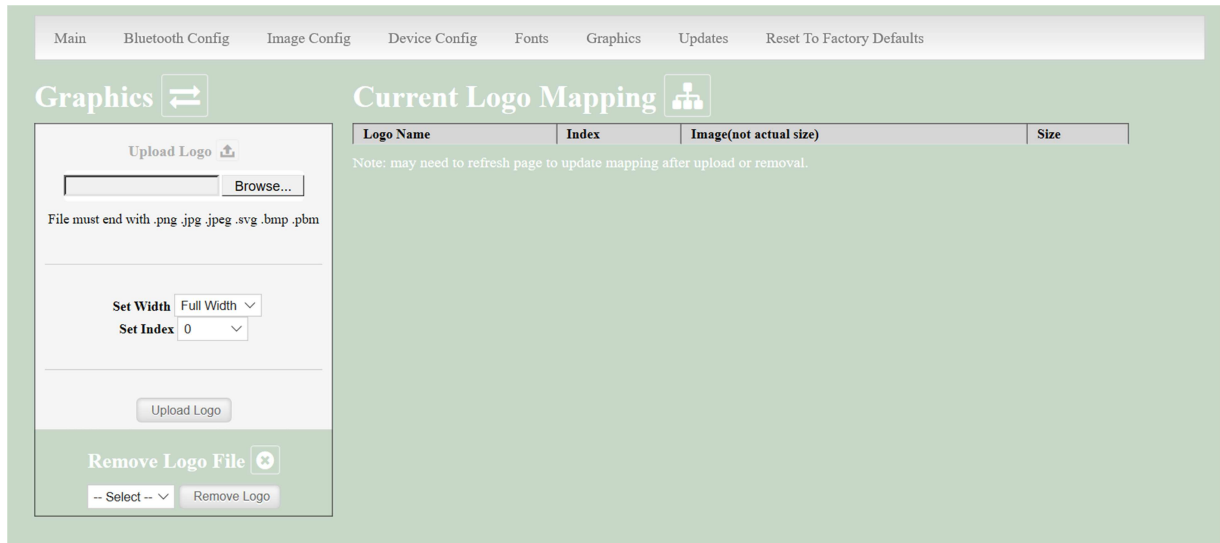

Upload File

Select the graphics file to load into printer memory. Acceptable graphics formats are .jpeg, .pbm, .pcx, .bmp, .png and .svg.

Set Width

Select the width you want to use to display your logo: full width, half width, or small width.

Set index

Depending on the Index value used, you can automatically print the graphics file as a header (prints at the beginning of the print job), footer (prints at the end of a print job) or use the graphics print command to print anywhere on your receipt or label. See *Integrator's Guide* for more information on graphics commands.

When selecting header, the graphics file will automatically print the logo at the beginning of each print job. When selecting footer, the graphics file will automatically print the logo at the end of each print job.

You must set each of these values before selecting Upload Logo or the default values will be associated with your image.

Current Logo Mapping

Once uploaded into the printer memory, your image and settings will be displayed here.

F. Update Printer Firmware, Upload Files to Printer Memory

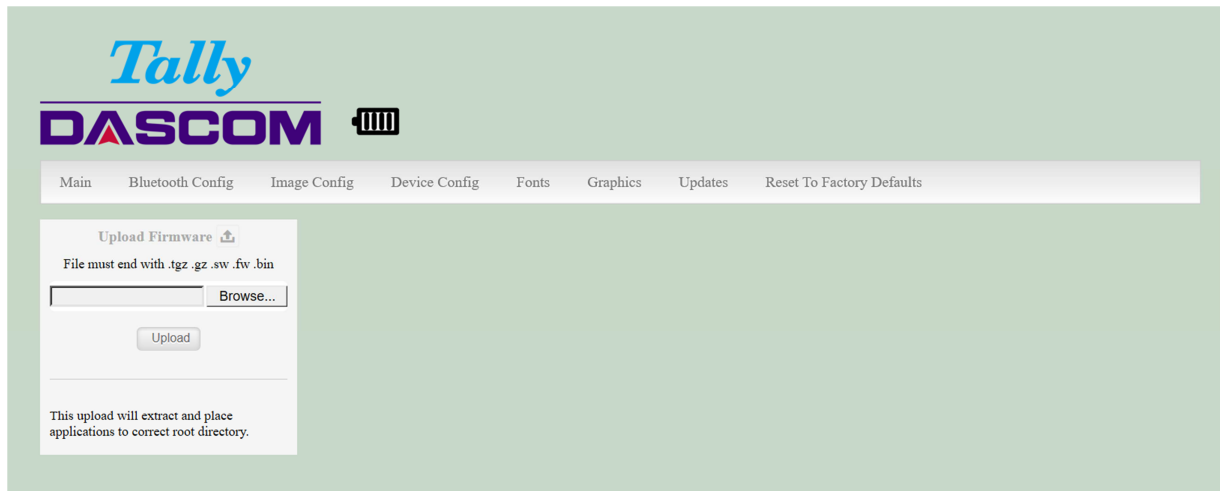

Printer Application Updates, OEM information and Manuals and more can be uploaded here:
www.dascom.com

Contact Technical Support of your Dascom Representatives for more information.

G. Reset Printer Configuration to Factory Defaults (Safe Mode)

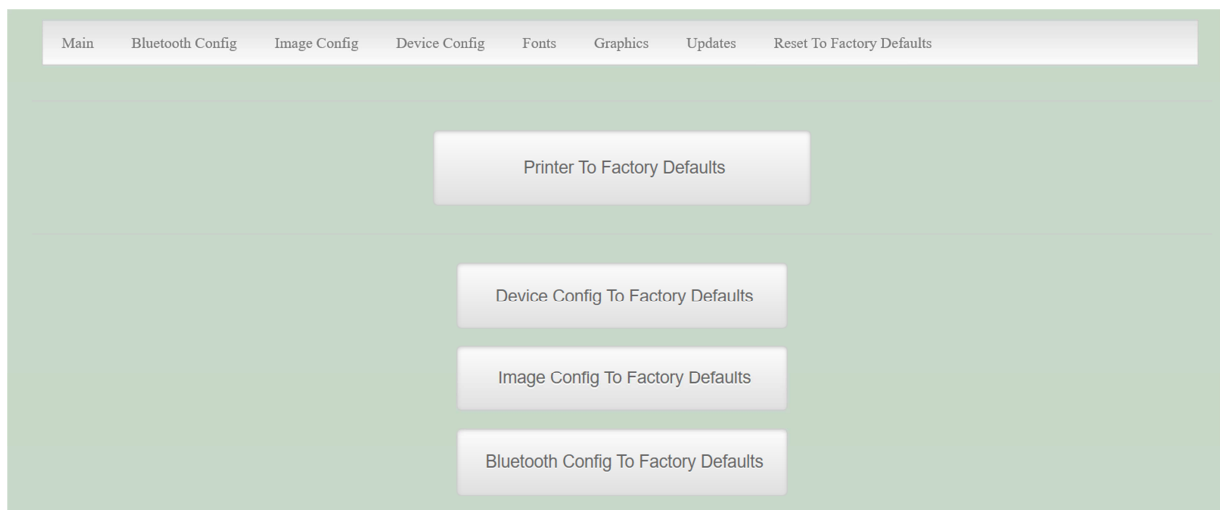

Printer settings can be restored to factory configurations.
Note that WIFI network configurations will be lost when Network Config to Factory Defaults is checked.

Media

A. Standard Media

Dascom offers a variety of media types. See [Appendix D](#) for detailed descriptions and ordering information. You may also visit our website, or contact your Dascom sales representative for a complete and up to date description of our consumables and accessory products.

B. Black Mark Media Position

For automatic ticket printing, the black mark should be positioned as shown in the figure below. The black mark **MUST** be on the front of the paper. When using Mark Sensing mode, VehiclePro printers will automatically position the output for tear-off and printing following a Form Feed command or by pressing the Paper Feed button.

For non-automatic paper positioning, refer to the 541 *Integrator's Manual* for sensing and positioning commands.

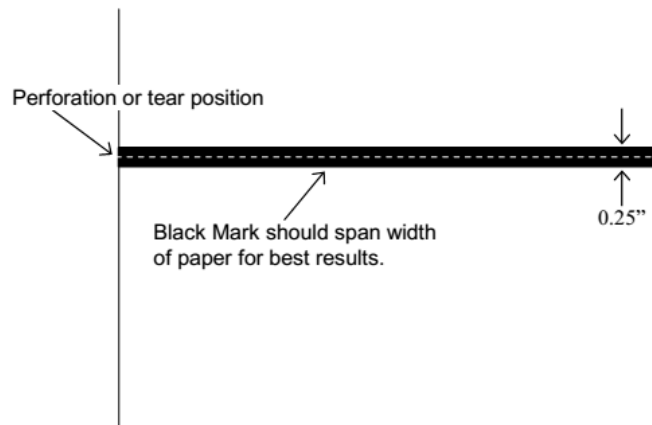

Optimum Black Mark Position

Maintenance and Troubleshooting

A. Cleaning

In normal environments, the printer should be cleaned after printing a few rolls of paper or if there are voids in the printout. For optimum performance and life, you should clean the Print Head and Platen Roller whenever you load new paper.

To clean the printer areas as described below, use a Thermal Head Cleaning Pen available from Dascom, or you may use cotton swabs moistened with isopropyl alcohol.

- Turn the printer off. Open the Paper Door and remove the paper.
- Using a Thermal Head Cleaning Pen, clean the surface indicated on the Print Head.
Caution: Do not use sharp objects to clean the print head. This may damage the printer and require service. Such damage is not covered under warranty.
- Clean the Black Mark Sensor below the print head.
- Clean the Platen Roller. Turn the platen roller with your finger to clean the entire surface.

You may also experience a buildup of paper dust in the printer. This may be removed using a can of compressed air or by vacuuming.

To clean the exterior of the printer, turn the printer off and use a soft cloth moistened with a mild detergent.

B. Troubleshooting

When encountering problems, the cause may be the printer or may sometimes be due to other problems with your system. Please review the following tables to solve common problems you may encounter with your printer. You may also visit www.dascom.com for additional "FAQ's" that may assist you.

If you are still unable to solve your problem, please contact the company where you purchased your printer since they are most familiar with your systems. If they are unable to help you, you may contact the Technical Support of your Dascom Representatives.

I. Error Conditions

Whenever the printer detects an error condition the Error Indicator will either flash or stay on. In some cases the audible alarm will also sound. Please refer to the following table for a list of what causes these conditions and how they may be corrected.

Error Indicator	Possible Cause	Solution
Flashes Red	Paper Out	Install paper and press the Paper Feed Button to clear the error.
Flashes Green/Amber, Without Alarm	Paper door not fully closed.	Make sure the door is fully closed by opening the door and closing it again until the door "clicks" closed. Check the platen roller for damage.
Flashes Green, Without Alarm, No Printout	Communications error.	Verify communications settings in the Interface Menu. Printer must be turned off to clear error.

II. Other Problems

Problem	Possible Cause	Solution
Poor print quality.	Print head dirty.	Clean print head as described in Maintenance and Troubleshooting .
	Poor quality or "old" paper.	Verify paper from approved source. Try new roll of paper.
Paper not feeding.	Obstruction in paper path or paper improperly installed.	Check paper path and reinstall paper.
	Poor quality paper.	Verify paper from approved source.
	Paper Door not fully closed.	Verify door is closed.
Paper not feeding reliably or print is compressed vertically	Poor quality paper.	Verify paper from approved source.
	Heavy or thick forms. Specialty paper with slick finish.	Lower the Max Paper Speed in Format Menu.
	Paper Door not fully closed.	Verify door is closed.
Print Garbled.	Improper Serial Interface configuration.	Verify printer and host settings match.
	Paper Door not fully closed.	Verify door is closed.
Printer will not print.	Paper not loaded correctly.	Check paper path and reinstall paper.
	Improper interface configuration.	Verify printer and host settings match. Print a self-test to verify printer settings and to verify printer is functioning properly.
Cannot print via optional interface.	Interface not configured correctly.	Print a self-test to verify printer settings. Make sure the interface is selected and make sure printer and host set ups match.

C. Obtaining Service

If service is required for your printer, please contact the company where you purchased your printer. If they are unable to assist you, contact the Customer Service of your Dascom Representatives.

If you wish to return your printer to Dascom for service, please contact Dascom Customer Service to obtain a Return Authorization Number. Units returned without a Return Authorization will not be accepted.

DASCOM Representatives:

Germany :	DASCOM Europe GmbH, Heuweg 3, D-89079 Ulm, Phone: +49 (0) 731 2075 0
UK:	DASCOM GB Ltd, Hart House, Priestley Road, Basingstoke, Hampshire, RG24 9PU, P: +44 (0) 1256 481481
France:	DASCOM Europe GmbH, 117 Avenue Victor Hugo 92100 Boulogne-Billancourt, Phone: +33 (1)73 02 51 98
Singapore (AP):	DASCOM AP Pte Ltd, 21 Bukit Batok Crescent, #29-81, WCEGA Tower, 658065, Phone: +65 6760 8833
Americas:	Dascom Americas Corp, 34 Lakeview Court, Verona, VA 24482, USA, Phone: +1 (877) 434 1377
China:	Jiangmen Dascom Computer Peripherals Co., Ltd, No.399, jinxing Road, Jianghai District Jiangmen

APPENDIX

A. Appendix A – Tally Dascom DPV-541 Printer Specifications

Printing Specifications

Printing Method: Direct thermal.
Printing Resolution: 203 dpi (8 dots per mm).
Printing Speed: Up to 4 ips
Printing Width: Up to 4.1 inches (10.4 cm).
Paper Width: 4.125 inches (10.8 cm).

Fonts/Characters/Bar Codes

Fonts: A wide range of font types and sizes, from ~6 cpi to 34 cpi depending on emulation chosen, plus scaling.
Bar Codes: Code 39, Code 128, Intiv 2 of 5, EAN08 & 13, PDF-17 and UPC, depending on emulation chosen.
Downloadable graphics, logos. Accepts any .ttf font for download.

Connectivity

Standard: RS232, USB (optional cable required)
Wireless Options:
Bluetooth®
Bluetooth® 4.0
Including:
Protocols: L2CAP, RFCOMM, SDP
Profiles: GAP, SDAP, SPP
Wi-Fi 802.11b/g/n compatible

Software

Drivers and Utilities: Drivers for WIN 7, WIN 10. Compatible with Windows Mobile, Android

Printer Setup Program provides convenient configuration via a Windows Interface from any computer, tablet PC, or smartphone.
Emulations: Emulates many popular printer brands and languages including: CPCL, ZPL and ESCPOS

Print Media

Paper Type: Direct Thermal Roll.
Roll Size: Maximum roll diameter 1.75" (4.3 cm), roll widths from 2.9" to 4.125" (7.4 to 10.5 cm)
Roll Capacity: Approx. 65' (19.8 m). or approx. 130 – 6" long receipts (with 2.4 mil thick media). max.
Core Size: 0.75" Recommended (19 mm).

Power Management

9-32 VDC in-vehicle power.
Auto ON/OFF with vehicle power.

Physical Specifications

Fits standard console, 3" high panel with a 5" depth.
Weight: 44.8 ounces with face panel.

Environmental Specifications

Operating Temp: -4° to 122°F (-20° to 50°C).
Storage Temp: -4° to 140°F (-20° to 60°C).
Humidity: 10% to 90% RH (non-condensing).
Rated IP54 per IEC 529

Operator Controls and Indicators

LED indicator for general status.
Button for paper feed.
Latch for paper compartment door.
All located conveniently on front face.

Memory Capacity

215MB Flash, 512MB DRAM. Standard memory supports large and graphic intensive print jobs.

Durability and Reliability

Case is all metal, consistent with heavy duty Police/Fire/Rescue equipment.
MTBF: >13 million print lines (Approx. 3,500 paper rolls)

Regulatory Approvals

CE mark, UL listed AC adapters, E-mark

Warranty

Two-year printer warranty on the entire printer- case and print head included. Optional extended warranty available, ask your sales rep for details.

Options and Accessories

- Media in case quantities.

Glossary of Terms

802.11	Wireless networking communication standards created by IEEE.
Ad-Hoc	A Wi-Fi network consisting of only stations (no access point). Same as Peer-to-Peer.
authentication	The process a Wi-Fi station uses to identify itself to another station.
baud rate	The rate at which characters are transmitted over a serial interface. This is also often referred to as bits per second.
Bluetooth	A definition for short range radio frequency communications.
client	Any node on a network that requests services from another node (server).
character pitch	The horizontal spacing of characters. Measured in cpi.
cpi	Characters per inch.
default	Value or configuration assumed when the printer is powered on or reset.
DHCP	Dynamic Host Configuration Protocol. A method used to centrally control the assignment of IP addresses on a network.
dpi	Dots per inch. Generally used to refer to graphics density or resolution.
font	A group of characters of a given shape or style.
infrastructure	A Wi-Fi network consisting of stations connecting to a wired network or other stations via an access point.
interface	The connection between the printer and the host computer.
IP	Internet Protocol. A specification for packets, or datagrams, of data and an addressing method to allow the exchange of data with another system. Must be combined with another protocol such as TCP to create a complete connection with the other system.
LAN	Local Area Network.
LED	Light emitting diode.
lpi	Lines per inch.
margin	An area along any edge of a form where data may not be printed.
Peer-to-Peer	A network consisting of only stations (no access point or central server). Same as Ad-Hoc.

reset	Initialization of various operating features of the printer to the value or state assumed when the printer is powered on.
server	Any node on a network that provides services to another node (client).
SSID	Service Set Identifier. An identifier attached to packets on a Wi-Fi network that identify the particular network the packets are intended for.
TCP	Transmission Control Protocol. A specification that controls the connection between systems on a network.
top of form	The vertical position where the first line is printed on the paper. Also the position the paper is advanced to when a form feed (FF) character is received from the host or the Form Feed button is pressed on the printer's control panel.
USB	Universal Serial Bus.
WAN	Wide Area Network. Refers to connections that allow one LAN to communicate with another LAN(s).
WEP	Wired Equivalent Privacy. A security protocol for wireless LANs designed to provide data security similar to a wired LAN.
Wi-Fi	Refers to any of the IEEE 802.11 standards.
WLAN	Wireless Local Area Network. A LAN made up of wireless nodes.

Index

- 802.11, 27
- Accessories, 26
- Add Enterprise Network**, 15
- Add Personal Network**, 15
- Address Method**, 13
- Ad-Hoc, 27
- Android, 3, 8
- Apple**, 9
- Authentication, 27
- AUTOIMAGE, 16
- Available Networks**, 14
- Backup Distance Before Printing**, 18
- battery, 11
- Baud Rate, 27
- Black Mark, 2, 22
- Bluetooth, ii, 2, 8, 11, 12, 26, 27
- Canadian Department of Communications Radio
 - Interference Statement, ii
- Character Pitch, 27
- Cleaning**, 23
- Client, 27
- Configuration**, 10, 27
- Connectivity Parameters**, 11
- Contrast**, 18
- CPCL, iii, 16, 26
- cpi, 26, 27
- Current Emulation**, 16
- Current Logo Mapping**, 20
- Current Printer Config**, 13
- Default, 27
- Default Font**, 16
- Default Text Line Spacing**, 17
- Device Config**, 17
- DHCP, 27
- Discoverability**, 12
- dpi, 26, 27
- Drivers**, 8
- Drivers, 26
- ESCPOS, 16
- FCC Part 15 Class B, ii
- Features**, 3, 28
- Font Aliases**, 19
- Fonts**, 19
- Form, 28
- Format Menu, 24
- Gap Paper Sensor Threshold**, 18
- GateWay**, 13
- Graphics**, 19
- IMAGE, 16
- Image Parameters**, 15
- Infrastructure, 27
- Installation: Cable**, 5; **Printer**, 6
- Interface, 2, 24, 27
- IP Address**, 13
- IP45, 3
- IPL, 16
- LAN, 28
- LED, 26, 28
- Left Margin**, 18
- lpi, 28
- Maintenance, 2, 23
- Margin, 28
- Mark Seeking**, 18
- Max Paper Speed**, 18, 24
- Media**, 22, 26
- Memory, 26
- Obtaining Service**, 25
- Paired Mode**, 12
- Paper: Loading, 3, 4
- Paper Energy Values**, 18
- Passkey, 8, 9
- PDF**, 16
- Peer-to-Peer, 28
- PIN**, 12
- POSTSCRIPT, 16
- Power Management, 26
- Quick Start Instructions**, 4
- Rear Paper Sensor Threshold**, 18
- Reset, 28
- Role Policy**, 12
- RS-232, 26
- Self-Test**, 7, 24
- Server, 28
- Set Date**, 14
- Set index**, 20
- Set Width**, 20
- Specifications, iii, 2, 3, 26; Environmental, 26;
 - Physical, 26
- SSID, 28
- Status Indications**, 7
- Stop Distance after Mark**, 18
- SubNetMask**, 13
- TCP, 28
- Troubleshooting, 2, 23
- Units**, 18
- Upload Digital Certificate**, 15
- Upload File**, 20
- Upload Font File**, 19
- USB, 8, 28; Cable, 2, 26
- WAN, 28
- Warranty, 26
- web page, 10
- WEP, 28
- Wi-Fi, iii, 27, 28
- Wi-Fi Config**, 11, 13
- Wifi Port**, 13
- Windows, 3, 8, 9, 26
- WindowsMobile, 3, 26
- WLAN, 28
- ZPL, 16