



User Manual

DL-830 Thermal Desktop Label Printer



## Important Safety Instructions (English)

Read the following instructions thoroughly before starting up your printer.

- Never carry out maintenance or repair work yourself. Always contact a qualified service technician.
- Keep this Operator's Manual in a place which is easily accessible at all times.
- Place the printer on a solid and even base so that it cannot fall.
- Never place the printer in the vicinity of inflammable gas or explosive substances.
- Ensure the printer is connected to a socket with the correct mains voltage.
- Always disconnect the printer from the mains before opening the device to perform maintenance work or remedy errors.
- Do not expose the printer to high temperatures, direct sunlight or dust.
- Keep all liquids away from the printer.
- Protect the printer from shock, impact and vibration.
- Make sure that the printer and computer are switched off before connecting the data cable.
- The print head will become very hot during printing; avoid contact with the print head after printing has finished.
- Do not perform any operation or action in any way other than those provided in this manual. When in doubt, contact your dealer or your customer support.



The device and mains-socket must all times be easily accessible.

---

## Wichtige Sicherheitshinweise (German)

Lesen Sie bitte diese Sicherheitshinweise durch, bevor sie den Drucker in Betrieb nehmen.

- Führen Sie Wartungsarbeiten und Reparaturen keinesfalls selbst aus, sondern verständigen Sie immer einen qualifizierten Servicetechniker.
- Bewahren Sie diese Dokumentation an einem jederzeit zugänglichen Ort auf.
- Den Drucker auf stabilem und ebenem Untergrund so aufstellen, dass er nicht zu Boden fallen kann.
- Stellen Sie den Drucker keinesfalls in der Nähe von leicht entzündlichen Gasen oder explosiven Stoffen auf.
- Den Drucker nur an eine Steckdose mit der richtigen Spannung anschließen.
- Wenn Sie den Drucker vom Netz trennen wollen, den Drucker ausschalten und immer den Netzstecker aus der Steckdose ziehen.
- Den Drucker weder hohen Temperaturen noch direktem Sonnenlicht und Staub aussetzen.
- Keine Flüssigkeiten mit dem Drucker in Berührung bringen.
- Den Drucker keinen Erschütterungen, Stößen oder Vibrationen aussetzen.
- Sicherstellen, dass der Drucker und der Computer ausgeschaltet sind, bevor das Datenkabel angeschlossen wird.
- Der Druckkopf wird während des Druckens heiß. Vor dem Berühren deshalb einige Zeit abkühlen lassen.
- Weichen Sie bei der Bedienung des Druckers nicht von den Anweisungen in der Dokumentation ab.  
Bei Unklarheiten wenden Sie sich bitte an Ihren Händler oder Ihren Kundendienst.
- Maschinenlärminformations – Verordnung – 3.GPSGV, der höchste Schalldruckpegel beträgt 70 dB(A) oder weniger gemäß EN ISO 7779.



Das Gerät und die Netzsteckdose müssen jeder Zeit leicht zugänglich sein.

---

## Consignes importantes de sécurité (French)

Lire attentivement les instructions suivantes avant de mettre l'imprimante en service.

- Ne jamais effectuer soi-même les travaux d'entretien et de réparations. Contacter toujours un dépanneur qualifié.
- Placer l'imprimante sur un support stable de façon à ce qu'elle ne puisse pas tomber.
- Ne jamais placer l'imprimante à proximité de sources de gaz aisément inflammables ou de substances explosives.
- Ne connecter l'imprimante à une prise que lorsque la tension est correcte.
- Pour déconnecter l'imprimante de l'alimentation principale, mettre l'imprimante hors tension et toujours débrancher le connecteur secteur de la prise murale.
- Ne pas exposer l'imprimante à des températures élevées, à la lumière directe du soleil ou à la poussière.
- Ne pas mettre l'imprimante en contact avec des liquides.
- Ne pas exposer l'imprimante à des chocs, impacts ou vibrations.
- S'assurer que l'imprimante et l'ordinateur sont hors tension avant de connecter le câble de données.
- La tête d'impression est brûlante pendant l'impression. C'est pourquoi laissez-la refroidir quelques instants avant d'y toucher.
- N'exécutez aucune opération ni action d'une autre manière que celle indiquée dans ce manuel. En cas de doute, veuillez contacter votre distributeur ou service après-vente.



Le dispositif et la prise principale doivent toujours être accessibles facilement.

---

## Indicazioni di sicurezza importanti (Italian)

Prima di mettere in funzione la stampante, leggere attentamente le seguenti indicazioni.

- Non eseguire mai da sé gli interventi di manutenzione e riparazione, ma rivolgersi sempre a un tecnico di assistenza qualificato.
- Conservare le presenti istruzioni per l'uso in un luogo sempre accessibile.
- Collocare la stampante su una superficie stabile, per evitare che cada a terra.
- Non collocare la stampante in prossimità di gas facilmente infiammabili o di sostanze esplosive.
- Collegare la stampante a una presa di corrente con tensione adeguata.
- Per scollegare la stampante dalla rete di alimentazione, spegnere la stampante e disinserire sempre il connettore di rete dalla presa.
- Non esporre la stampante ad elevate temperature né alla luce solare diretta e alla polvere.
- Evitare il contatto della stampante con liquidi.
- Non esporre la stampante a colpi, scosse o vibrazioni.
- Verificare che la stampante e il computer siano spenti prima di collegare il cavo di trasmissione dati.
- Durante la stampa, la testina si surriscalda notevolmente. Prima di toccarla, se necessario opportuno quindi lasciarla raffreddare qualche istante.
- Non eseguire alcuna operazione o azione se non nella maniera descritta nel presente manuale. In caso di dubbio, contattare il rivenditore o dalla società incaricata dell'assistenza.



Il dispositivo e la presa di corrente devono essere sempre facilmente accessibili.

---

## Instrucciones de seguridad importantes (Spanish)

Lea las siguientes instrucciones con esmero antes de poner la impresora en servicio.

- Nunca lleve a cabo trabajos de mantenimiento o reparación Ud. mismo, sino consulte a un técnico de servicio calificado.
- Guarde las presentes instrucciones de servicio en un lugar de fácil acceso en cualquier momento.
- Ponga la impresora sobre un base estable de manera que no pueda caer al suelo.
- Nunca coloque la impresora en la vecindad de gases de fácil inflamabilidad o sustancias explosivas.
- Asegure conectar la impresora sólo a un enchufe con un voltaje correcto.
- Cuando quiera desconectar la impresora de la red, apague la impresora y siempre tire la clavija de alimentación del enchufe.
- No exponga la impresora a temperaturas altas, a la luz solar directa y al polvo.
- No ponga la impresora en contacto con fluidos.
- Nunca exponga la impresora a sacudidas, choques o vibraciones.
- Asegúrese de que la impresora y el ordenador estén apagados antes de conectar el cable de datos.
- La cabeza de impresión se pone muy caliente durante la impresión. Por lo tanto, deje enfriarlo algún tiempo antes de tocarla.
- No permita que se realice cualquier operación o acción de una forma diferente a lo que se señala en el manual. En caso de duda, póngase en contacto con su comerciante o con su servicio post-venta.



El dispositivo y la toma de corriente deben estar ubicados de forma que sea fácil acceder a ellos.

---

## Правила по технике безопасности. (Russian)

Прочитайте, пожалуйста, инструкцию по технике безопасности перед включением в работу принтера.

- Не выполняйте технические работы и ремонт техники самостоятельно, но сообщайте о неисправностях квалифицированным сервисным техникам.
- Данная инструкция должна быть всегда доступна каждому пользователю.
- Установите принтер на ровном и стабильном месте так, чтобы он не смог упасть на пол.
- Ни в коем случае не ставьте принтер вблизи легко воспламеняющихся газов и взрывчатых веществ.
- Включайте принтер в розетку только с соответствующим напряжением.
- Если Вы хотите отключить принтер от напряжения, сначала выключите принтер сам и затем выньте штекер из розетки.
- Берегите принтер от нагревания, от попадания на него прямых солнечных лучей и пыли.
- Не допускайте попадания жидкости на принтер.
- Нельзя подвергать принтер тряске, ударам и вибрации.
- Убедитесь, что принтер и компьютер выключены, только после этого соедините принтер с компьютером.
- Печатающая головка нагревается во время работы принтера. Поэтому подождите какое-то время, прежде чем дотронуться до нее.
- Пользуйтесь принтером так, как это написано в документации. Если у Вас возникают неясности, обращайтесь с вопросами к Вашим продавцам или в сервисный центр.



Устройство и розетка должны быть всегда легко доступна.

---

## Instruções Importantes sobre Segurança (Portuguese)

Leia as instruções de segurança antes de usar a impressora.

- Consulte sempre um técnico qualificado para executar uma reparação .
- Coloque a impressora sobre uma base sólida e nivelada, para que ela não sofra quedas.
- Jamais instale a impressora nas proximidades de lugares onde haja gás inflamável ou substâncias explosivas.
- Assegure-se de conectar a impressora à tomada elétrica com a voltagem apropriada.
- Quando desligar a impressora da rede, desligue sempre a impressora e retire o cabo da tomada.
- Não exponha a impressora a temperaturas altas ou luz solar direta.
- Não aproxime substâncias líquidas da impressora.
- Proteja a impressora de choques, impactos e vibrações.
- Desligue a impressora e o computador antes de conectar o cabo da rede.
- A cabeça da impressora pode ficar muito quente . Portanto, espere algum tempo antes de tocá-la.
- Não faça nenhuma operação ou ação além das recomendadas neste manual. Em caso de dúvida, contate seu revendedor ou companhia de serviço.



A impressora e a tomada devem ser facilmente em todos os momentos acessíveis.

---



## Önemli Güvenlik Talimatları (Turkish)

Lütfen, yazıcıyı işleme geçirmeden önce bu güvenlik talimatlarını bütünüyle dikkatle okuyun.

- Bakım ve tamir çalışmalarını kesinlikle ve hiçbir surette kendi başınıza yapmayın; her zamankali fiyebir uzman servis-teknişyenine haber verin.
- Yazıcıyı, üzerinden yere düşmesimümkün olmayacak sabit ve düz bir zemine yerleştirin.
- Yazıcıyı kesinlikle ve hiçbir surette kolayca yanabilecek gaz veya patlayıcı maddeler içeren nesnelerin yakınına koymayın.
- Yazıcı kım kablosunu sadece doğru gerilime sahip bir prize takın.
- Yazıcıyı şebeke ağından ayırmak istediğinizde, yazıcıyı kapatın ve ağ-fişini her zaman prizden çıkartın.
- Yazıcıyı ne yüksek ısı ne de doğrudan güneş ışığına ve toza mâruz kalan mekânlarda bulundurun.
- Yazıcı hiçbir sıvı maddeyle temasta olmamalıdır.
- Yazıcı hiçbir sarsıntıya, darbeye veya titreşime mâruz kalmamalıdır.
- Veri kablosu bağlanmadan önce hem yazıcının hem de bilgisayarın kapalı olduklarından emin olmalısınız.
- Yazıcının başı basma esnasında yüksek ısıya ulaşıyor. Bu yüzden lütfen dokunmadan önce kısa süre soğumasını bekleyin.
- Yazıcının işletimi ve kullanımında bu dokümantasyondaki talimatların hiç dışına çıkmayın. Sorunlu görünen hususlarda lütfen imâlatçınıza veya müşteri hizmetleri servisimize başvurun.



Cihaz ve elektrik prizinin her zaman kolayca erişilebilir olması gerekir.

## TRADEMARK ACKNOWLEDGEMENTS

“IBM” is a trademark of International Business Machines Corporation.

“EPSON” is a trademark of Epson America Incorporated.

“DEC” is a trademark of Digital Equipment Corporation.

“Centronics” is a trademark of Centronics Data Computer Corporation.

“DOS” is a trademark of Microsoft Corporation.

“SAP” is a trademark of SAP AG.

“Windows”, “Windows 7”, “Windows 8”, “Windows 10”, “Windows 95”, “Windows 98”, “Windows NT”,

“Windows 2000”, “Windows 2003/2008/2013 Server”, “Windows XP” and “Windows Vista” are trademarks of Microsoft Corporation.

All other product names and company names appearing in this manual are the registered trademarks or trademarks of the individual companies.

## APPROVALS



This device fulfils the European standards requirements by complying with the Directive relating to electromagnetic compatibility and relating to low-voltage electrical equipment. Furthermore, it fulfils the requirements for RoHS and RED if applicable.

Conformity with the above-mentioned Directives is indicated by the CE symbol attached to the device.

Note: Conformity may be affected by:

- using interface cables not complying with the specifications
- non-observance of important instructions in the operator's manual
- installing components not approved for this device by the manufacturer
- unauthorized manipulation



Dieses Gerät erfüllt die Anforderungen der Europäischen Normen durch Einhaltung der Richtlinien bezüglich der Elektromagnetischen Verträglichkeit sowie bezüglich Elektrischer Betriebsmittel mit Niederspannung. Des Weiteren werden die Anforderungen bezüglich RoHS und falls anwendbar RED erfüllt.

Die Konformität zu den oben angeführten Richtlinien ist durch das am Gerät angebrachte CE-Zeichen gekennzeichnet.

Hinweis: Die Konformität kann beeinflusst werden durch:

- Benutzung von nicht spezifizierten Schnittstellen
- Nichtbeachtung wichtiger Hinweise der Bedienungsanleitung
- Ersetzen von Bauteilen, die nicht vom Hersteller für dieses Gerät freigegeben wurden
- Eingriffe durch Unbefugte



This device complies with the requirements of the United Kingdom (UK) legislation of Electrical Safety Regulations, Electromagnetic Compatibility Regulations, if applicable the Radio Regulations and the Restriction of the Hazardous Substances in Electrical and Electronic Equipment Regulations.

## About This Manual

This manual provides information to operators of DL-830 to describe basic operation to enable safe and correct use of the printer.

## Symbol Description

The symbols in this manual are identified by their level of importance, as defined below. Read the following carefully before handling the product.



**CAUTION:** Provides information that must be observed to prevent damage to the equipment or data loss.



**NOTE:** Advises you of information that is essential to complete a task.

## Related Software and Documents

Related Software and Documents

Software/document name	Description
DL-830 User Manual	This manual.

---

# Contents

<b>CHAPTER 1 INTRODUCTION.....</b>	<b>1</b>
1.1 Features.....	1
1.2 Specifications.....	2
1.3 Consumables.....	4
1.4 Size and Weight.....	5
1.5 Unpack and Inspect.....	6
1.6 Standard/Optional Components for the Product.....	7
1.7 Key Components.....	8
1.8 Control Panel.....	13
1.8.1 Normal/Setup Modes Operation.....	13
1.8.2 Four Major Setup Menus.....	14
1.8.3 Sample for Setup Steps.....	14
1.9 Displayed Error Messages.....	15
<b>CHAPTER 2 INSTALLATION.....</b>	<b>1</b>
2.1 Recommended Installation Procedures.....	1
2.2 Suitable Installation Site.....	1
2.3 Connect the Power.....	2
2.4 Adjust the Media Sensors.....	3
2.4.1 Two Types of Media Sensors.....	3
2.4.2 Relocate the Gap Sensor.....	4
2.4.3 Relocate the (Reflective) Black Mark Sensor.....	4
2.5 Load the Media.....	5
2.5.1 Loading Procedures.....	5
2.5.2 Adjust the Media Thickness and Width.....	7
2.6 Load the Ribbon.....	9
2.6.1 Loading Procedures.....	9
2.6.2 Resolve the Wrinkled Ribbon by Adjusting the Ribbon Balance Gear.....	10
2.6.3 Resolve the Wrinkled Ribbon by Adjusting the Ribbon Supply Leveler.....	11
2.7 Connect the Interface.....	12
<b>CHAPTER 3 SOFTWARE INSTALLATION.....</b>	<b>13</b>
3.1 Installing the Driver.....	13
3.2 Installing the Configuration Tool.....	16
3.3 Config Tool “Connect” Setup Process.....	19
3.4 Using the Configuration Tool.....	23
3.4.1 Setup for the Media with Black Marks.....	23
3.4.2 Setup for the LAN Connection.....	24
3.4.3 Setup for the WiFi.....	25
3.4.4 Setup for the Interface.....	26
3.5 Upgrading the Firmware.....	27
<b>CHAPTER 4 SUPPORT UTILITIES.....</b>	<b>29</b>
4.1 Configuration List (Self-test Page).....	29
4.2 Hex-dump.....	30
4.3 Auto Media Registration.....	30
<b>CHAPTER 5 DIAGNOSTICS AND MAINTENANCE.....</b>	<b>31</b>
5.1 Diagnostics.....	31
5.2 Restore Factory Default Settings.....	32
5.3 Clear Jammed Media.....	32
5.4 Clean the Print Head.....	32
5.5 Cleaning.....	32

---

---

<b>CHAPTER 6 INTERFACE SPECIFICATIONS.....</b>	<b>34</b>
6.1 USB.....	34
6.2 Ethernet.....	34
6.3 Parallel.....	35
6.4 Serial.....	36
6.5 Wifi.....	37
<b>CHAPTER 7 OPTION INTRODUCTION.....</b>	<b>38</b>
7.1 Using the Cutter.....	38
7.2 Using the Peeler.....	39
<b>CHAPTER 8 CODE PAGES.....</b>	<b>43</b>
8.1 ASCII CHARACTER SET.....	43
8.2 CP 437 USA.....	44
8.3 CP 850.....	45
8.4 CP 860 Portuguese.....	46
8.7 CP 858 European.....	49
8.8 CP 866 Cyrillic.....	50
8.9 CP 852 Latin.....	51
<b>CHAPTER 9 COMMAND CODES.....</b>	<b>53</b>
9.1 ZPL Command Set.....	53
9.2 EPL Command Set.....	57
9.3 TSPL Command Set.....	58
<b>FCC STATEMENT.....</b>	<b>60</b>

---

---

## CHAPTER 1 INTRODUCTION

Dascom designs this competitive industrial thermal label printer with the resolution of 300 dpi (dots per inch) printing at 5 ips (inches per second). Generous media storage and multiple emulations supporting ZPL, EPL, TSPL best fit for medical, manufacturing, logistics, retail & service, postal and education applications.

### 1.1 Features

- Nearly 90° cap opening for effortless media and ribbon replacement.
- Pull down to tear for easy cutting of short-width labels.
- Generous storage for 360-meter ribbon and 203 mm diameter media to reduce frequent replacement.
- Movable media sensor for precise positioning of media with off-center registration maker.
- Multiple interfaces: USB and LAN built-in, parallel option.

Other optional parts:

Cutter, label peeler,WiFi

## 1.2 Specifications

Print Parameter	Print method	Direct thermal/Thermal transfer printing
	Print width	Max. 106mm
	Print speed	Max. 5 ips (300dpi)
	Print head	Dot pitch: 0.08mm
	Resolution	300DPIx300DPI
Fonts	Chinese	GB18030 24x24 (Simplified/Traditional Chinese)
	Alphanumeric	Resident single byte (ZPL): Font A, Font B, Font D, Font E, Font F, Font G, Font H, Font V0, Font GS, Font P, Font Q, Font R, Font S, Font T, Font U, Font V
	User-defined	User-defined fonts can be downloaded into FLASH, SDRAM.
	Code Pages	EPL: PC437;PC850;PC852;PC860;PC863;PC865;PC857;PC861; ;PC862;PC855;PC866; PC737;PC851;PC869;Windows 1252;Windows 1250;Windows 1251; Windows 1253;Windows 1254;Windows 1255 ZPL: PC850, windows 1250, windows 1252, windows 1251, windows 1253, windows 1254, windows 1256
	Scalable /Rotation	Zoom in 1~8 times in vertical or horizontal, rotate by 0°, 90°, 180°, 270°.
Graphics	Graphics processing	Graphics (Monochrome PCX, BMP) can be downloaded into SDRAM.
Barcodes	1D	ZPL: Code11;Interleaved 2 of 5;Code 39;Code 49;Planet Code; EAN-8;EAN-13;UPC-E;UPC-A;Code 93;Code 128; Industrial 2 of 5;Standard 2 of 5;Codabar;MSI;Plessey EPL: EAN-8;EAN-13;UPC-E;UPC-A;Code 39;Code 93;Code 128; Interleaved 2 of 5
	2D	ZPL: PDF417;CODABLOCK;Maxicode;Aztec;QR Code; Data Matrix; EPL: PDF417;Maxicode;QR Code; Data Matrix;
Ribbon	OD	Max. $\phi$ 70mm (2.7 in)
	ID	$\phi$ 25 mm (1 in)
	Length	Max. 360 m
	Width	25.4~114mm
Media Handling	Media Spec.	Thickness 0.06~0.25mm
		Width 19.6mm~120mm
		Length 8.9~400mm
Max. OD $\phi$ 203mm (8 in)		
	ID $\phi$ 25.4 mm~76.2 mm (1 inch~3 inch)	
	Media cut	Tear bar, auto-cutter, peeler
	Media type	Roll paper, fanfold paper (continuous, non-continuous, continuous tag, wrist-band, normal media and all sorts of receipts )
Control Panel	Key	Four keys: Feed, Return, Pause, Cancel
	LED indicator	One LED: Power
	Screen	LCD
Detect Function	Standard sensors	Black mark sensor, Media sensor, Ribbon sensor, Machinery sensor

	Optional kit sensor	Label peel-off sensor
Emulation	Zebra	ZPL, EPL, TSPL
Power Supply	Input	AC 100V-240V, 50-60Hz
	Output	DC 24V; 1.5A
Memory	SDRAM	32MB
	FLASH	8 MB
Interface	Standard	USB (2.0 Full-Speed)
		Ethernet: 10M/100M
	Optional	Parallel Centronics (IEEE-1284)
		Wi-Fi Interface(802.11b/g)
		Serial:RS-232Serial (DB25)
Software		Driver (Windows 32bit/64bit), Bartender, SDK system
Physical Spec.	Dimensions	240(W)×440(D)×255(H)mm
	Casing Color	Black
	Weight	9.8kg
	Operating condition	0~45℃ / 20%~95%RH (non-condensing)
	Storage condition	-20~60℃ / ≤95%RH (non-condensing)
Certification		CE, FCC,ETL
Optional kit		Cutter, Peeler



## 1.3 Consumables

---



Important: Use genuine media to ensure the best print quality. The special designed paper, polyethylene and polyester media improve the performance and the print head life.

---

This printer supports three classes of print media:

- Adhesive Labels - individual label or continuous roll, with adhesive material on its back, laying over a backing tape (liner).
- Receipt - generally thermal sensitive paper in a roll.
- Ticket & Tag - generally made of thick paper (max. 0.25 mm); with perforation between label.

The print media can be in a roll or fanfold.

Thermal sensitive media (direct thermal) must be used without ribbon.

Choose correct type of media for your application.

## 1.4 Size and Weight

- Width: ~240 mm
- Length: ~ 440 mm
- Height: ~255 mm
- Weight: ~9.8kg



Front View



Rear View



Side View

## 1.5 Unpack and Inspect

Unpack and inspect if any shipping damage or missing parts compared with the packing list:

- Save all packing materials.
- Check if any exterior damages.
- Open the printer and inspect if any damages in the media compartment.

If you find shipping damage, keep the packing materials and notify the re-seller.

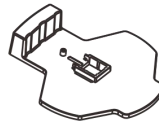
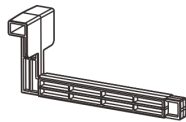
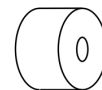
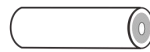
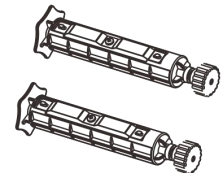
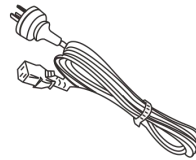
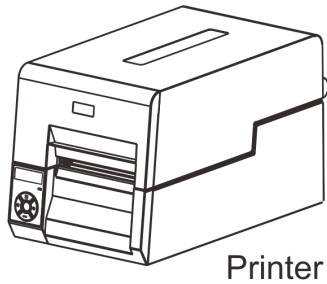

Contents in the packing list may vary according to your order.

Packing List for Standard Order:

Printer	1 unit	
Ribbon rewind paper core	1 piece	
Ribbon	1 piece	Wax
Ribbon spindle	2 pieces	
Thermal Paper	1 piece	Thermal Paper
Media Holder	1 piece	
Media Width Adjuster	1 piece	
Power cord	1 piece	EU/UK/US
Installation guide	1 piece	

### 1.6 Standard/Optional Components for the Product

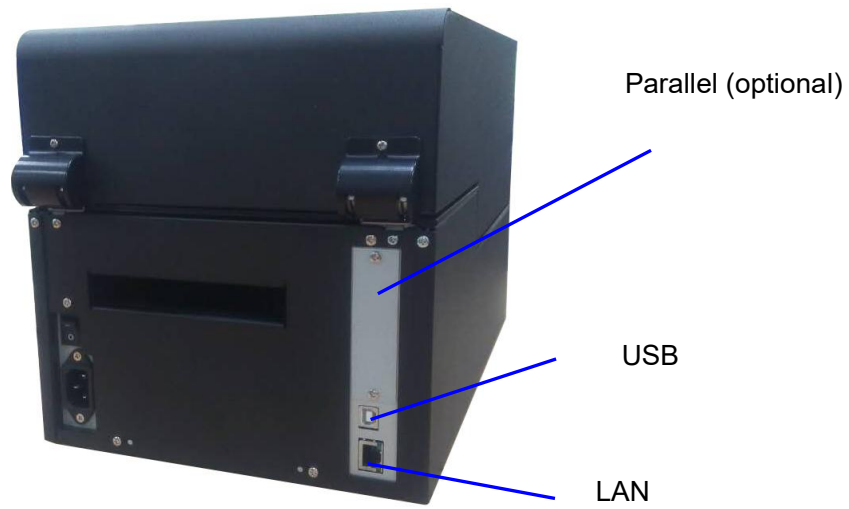

Product	Interfaces						Cutting			Sensor
	USB	LAN	Serial	Parallel	WLAN	Blue tooth	Tear	Cutter	Label Peeler	Black Mark
DL-830	√	√	O	O	O	X	√	O	O	√

Remarks: “√” denotes standard component.

“O” denotes optional component.

“X” denotes unavailable component.

## 1.7 Key Components

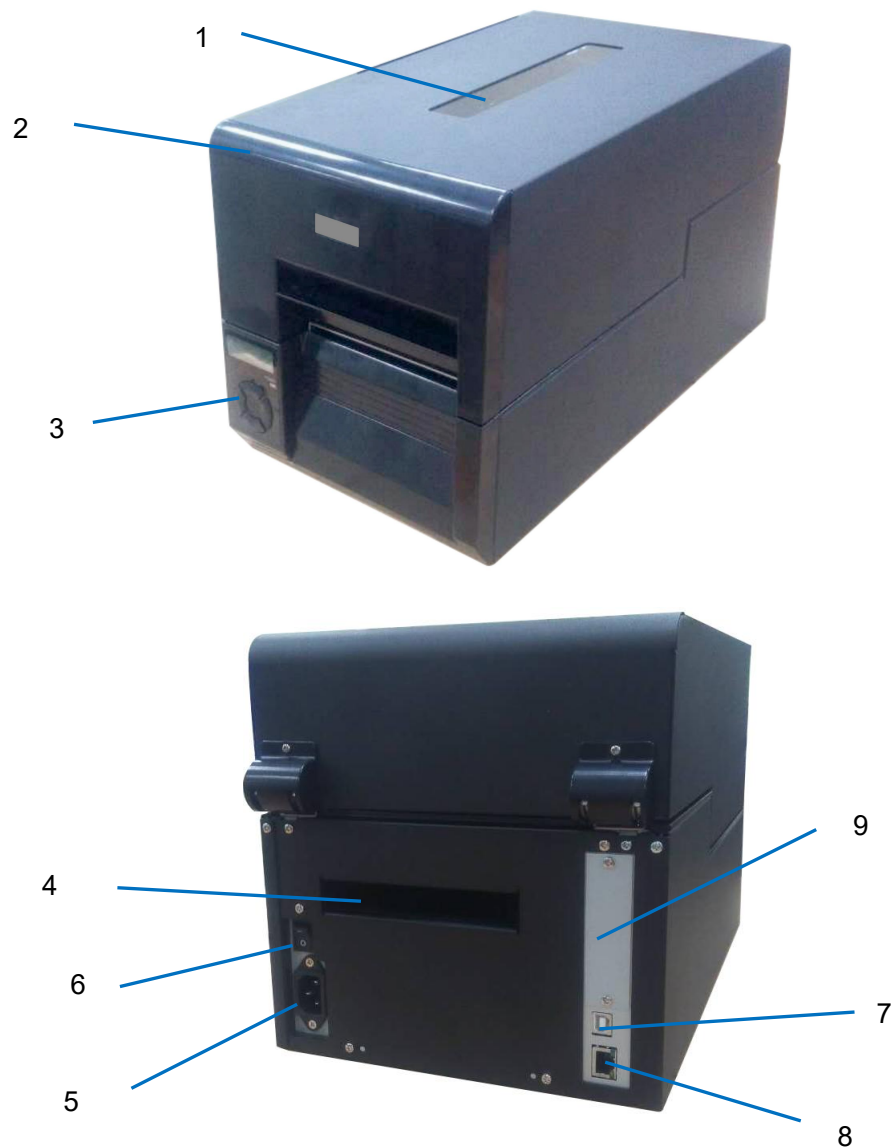

No.	Part Names	Descriptions
1	Transparent Window	Observe quantity of remained media.
2	Top Cover	Open to replace media or ribbon.
3	Control Panel	Configure the parameters and check the settings.
4	Rear Slot	An opening to load fanfold media
5	Power Socket	Socket for detachable power cord.
6	Power Switch	Turn on and off the printer
7	USB Interface	USB connection to PC (ex-factory standard interface)
8	LAN Interface	LAN connection to the server (ex-factory standard interface)
9	Optional interface: parallel	Optional interface to the PC. (Ordered separately)

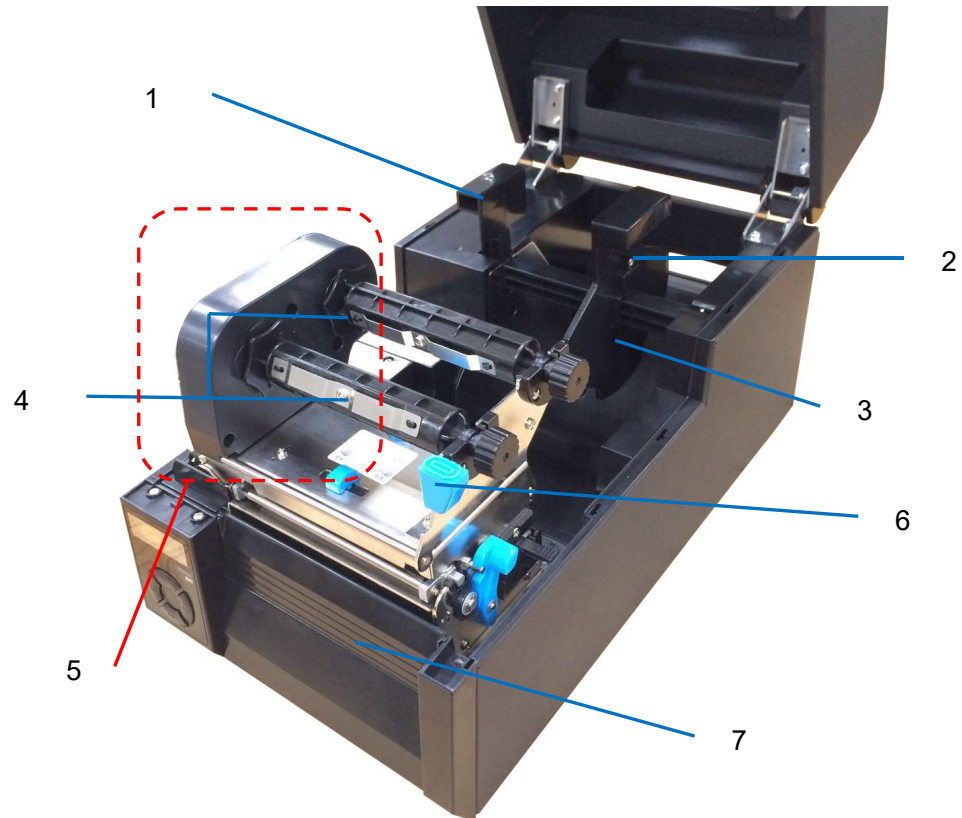

No.	Part Names	Descriptions
1	Media Holder	With the Media Width Adjuster, they hold the media roll in position.
2	Media Width Adjuster	Adjust it along the shaft of the Media Holder to match the width of the media.
3	Media Compartment	Generous space for media roll.
4	Ribbon Spindles	One to supply and the other to rewind the ribbon.
5	Ribbon Drive Module	The mechanism to supply and rewind the ribbon.
6	Engage Handle	Press it to latch the print head/ribbon module in place.
7	Front Cover	To be removed if optional cutter or label peeler is installed.

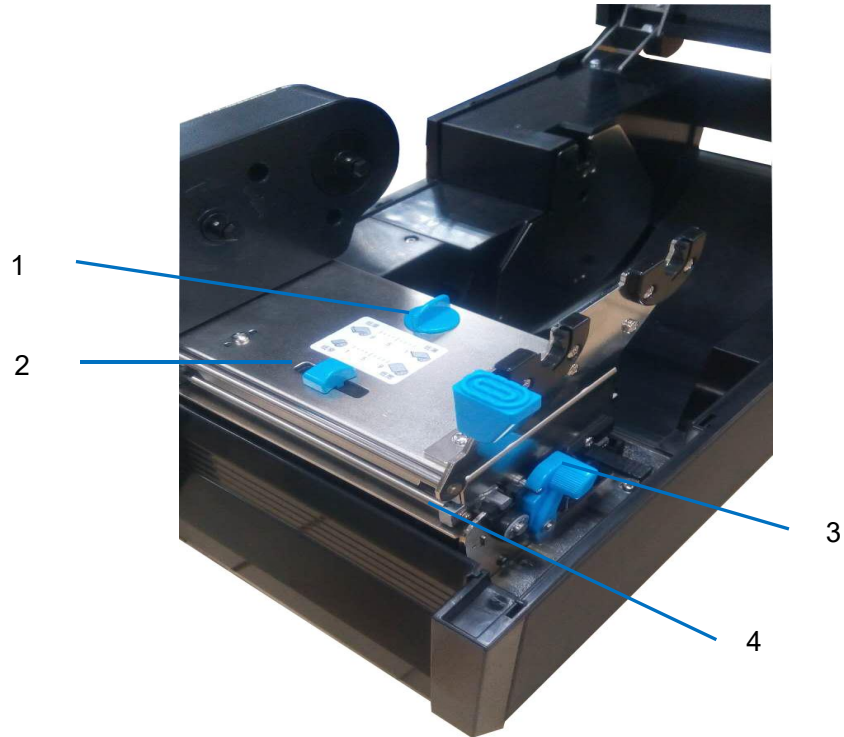

No.	Part Names	Descriptions
1	Media Thickness Dial	Turn it to match with the media thickness
2	Media Width Slider	Slide it to match with the media width.
3	Release Lever	Push it to release the print head/ribbon module.
4	Ribbon Balance Gear	Turn it to balance the ribbon tensions to correct wrinkled ribbon on the winding side.

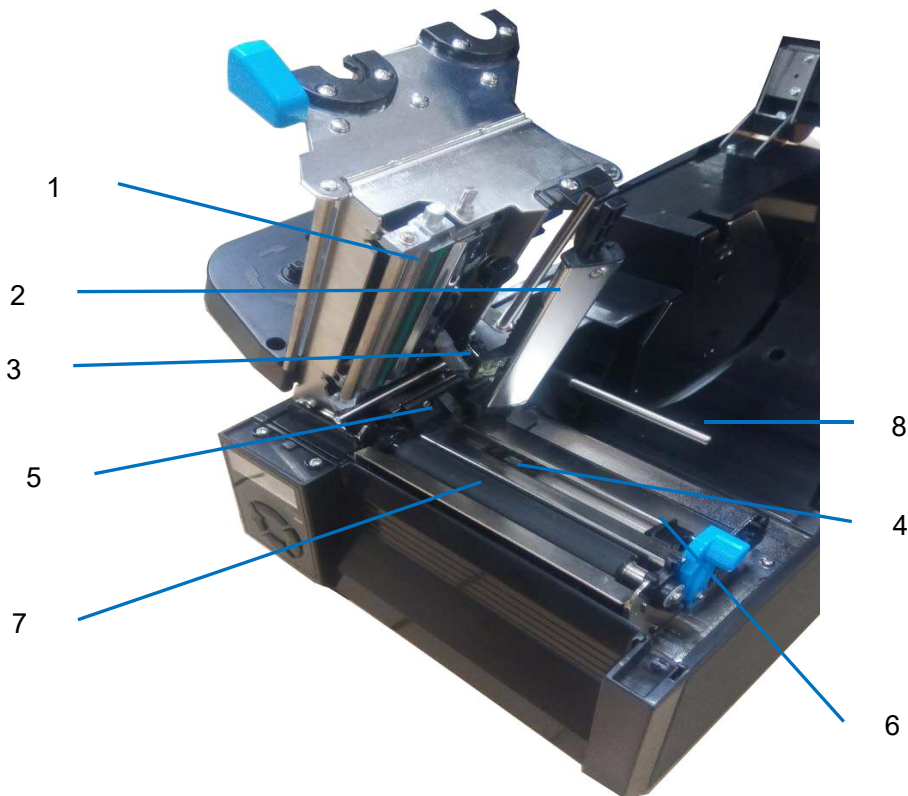

No.	Part Names	Descriptions
1	Print head	Never touch the head surface with fingers which contaminate the head with grease or dirt.
2	Sensor Arm	In normal position, it guides the media feeding. Lift it up to load media.
3	Gap Sensor	Media registration by identifying the notch or gap separating adjacent tags or labels.
4	(Reflective) Black Mark Sensor	Media registration by identifying the black mark pre-printed on the backside of the media.
5	Left Media Guide, fixed	Guard the left edge of the media.
6	Right Media Guide, movable	Free to move guide guarding the right edge of the media.
7	Feeding Roller	The friction between it and the print head drives printed media out of the printer.
8	Damper	It prevents media getting curved in high speed printing.



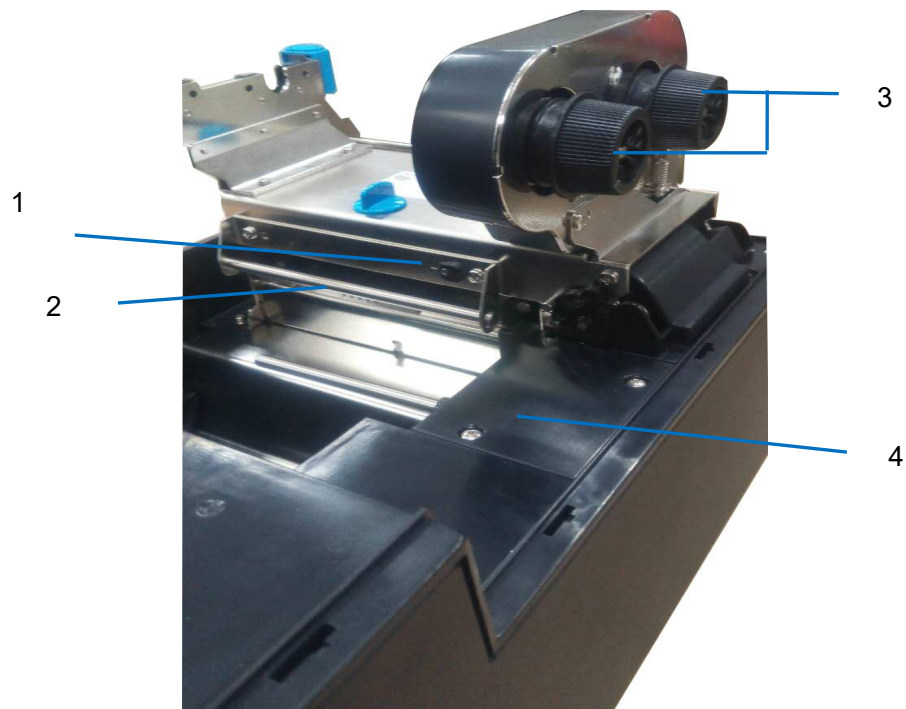

No.	Part Names	Descriptions
1	Ribbon Supply Leveler	It corrects ribbon wrinkle on the supply side by changing the tilted angle of the ribbon guide to balance the ribbon left/right tension.
2	Ribbon Guide Shaft	A routing pole for ribbon winding.
3	Ribbon Knobs	Turn the knobs to tighten up the ribbon on loading or wrinkled.
4	Option Cover	Open this cover to plug in the connectors for optional cutter or label peeler. Keep it closed if no options installed.

## 1.8 Control Panel

### 1.8.1 Normal/Setup Modes Operation

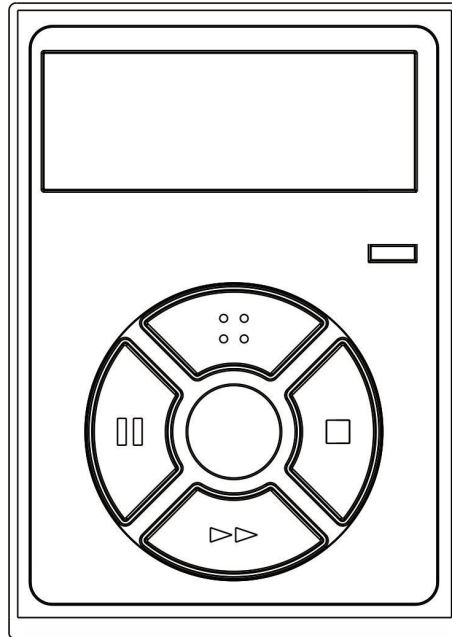

	Normal Mode (Ready to print operation)	Setup Mode
LCD	<ul style="list-style-type: none"> <li>● The 1<sup>st</sup> and 3<sup>rd</sup> lines constantly shows the model name and Setup, respectively.</li> <li>● The 2<sup>nd</sup> line shows the current status, or the error message if a fault occurs.</li> </ul>	<ul style="list-style-type: none"> <li>● The 1<sup>st</sup> line constantly shows the model name.</li> <li>● When the 2<sup>nd</sup> line shows one of the five major configuration menus, the 3<sup>rd</sup> line shows Setup.</li> <li>● When the 2<sup>nd</sup> line shows a sub-menu configuration, the 3<sup>rd</sup> shows the valid setting value.</li> </ul>
Power LED	Lights up to indicate the printer is turned on.	Lights up to indicate the printer is turned on.
⋮ button	Enter Setup mode.	Press twice to terminate the given item/value
▮▮ button	Pause the print job.	Scroll backward
■ button	Complete the current print job; then suspend the printer.	Scroll forward
▶▶ button	<p>For non-continuous media, advance to next label or top-of-form position.</p> <p>For continuous media, a press feeds the media 1 line; holding this button feeds multiple lines until the button is released.</p> <p>This action varies if options are enabled:</p> <ul style="list-style-type: none"> <li>● Label peeler: the label is fed to the peel off position. Further pressing the ▶▶ button has no effect until the label is removed.</li> <li>● Auto-cutter: Printed label is fed to cut position directly.</li> </ul>	Accept the given item/value.

## 1.8.2 Four Major Setup Menus

Machine Information

System Setup

Net Config

Test Mode

## 1.8.3 Sample for Setup Steps

Below describes how to [change the Print Density setting from 8 to 9](#) by panel operation.

1. The printer originally works in Normal mode with the follow display.

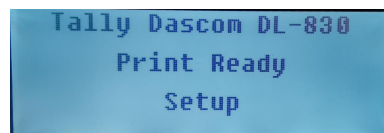

2. Press **⋮** button once to enter Setup mode. Press **■** button once to scroll forward getting the System Setup menu.

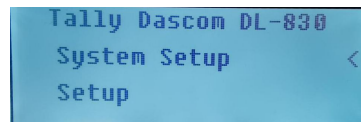

3. Press **▶▶** button once to accept entering the System Setup menu. Keep pressing **■** button to scroll to Print density sub-menu.

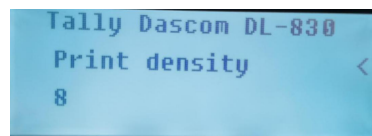

4. Press **▶▶** button once to accept entering the Print density setting. Press **■** button once to scroll the value from 8 to 9.

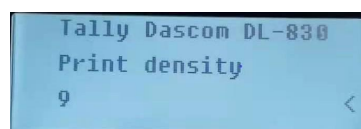

5. Press **▶▶** button to accept saving the value of 9 for Print density.
6. Press **⋮** button twice to terminate Setup mode and return to Normal mode.

## 1.9 Displayed Error Messages

Besides showing the Normal status, the LCD displays error messages when faults occur:

LCD Message	Causes
Print Ready Setup	The printer is in good operating condition and ready to print.
Pause Setup	The <b>   </b> or <b>■</b> button on the Control Panel is press.
Head hot Setup	This warns abnormal print head temperature.
Head Up Setup	The print head is lifted up.
Paper Out Setup	This warns out of media.
Calibrate Error Setup	This warns not able to detect media present.
Calibrate Error Setup	This warns jammed media.
Ribbon Out Setup	This warns ribbon ended.
Ribbon Out Setup	This warns slipping ribbon winding.
Cutter Error Setup	*This warns cutting action is interfered by foreign objects.

\* Valid if auto-cutter option is installed.

## CHAPTER 2 INSTALLATION

### 2.1 Recommended Installation Procedures

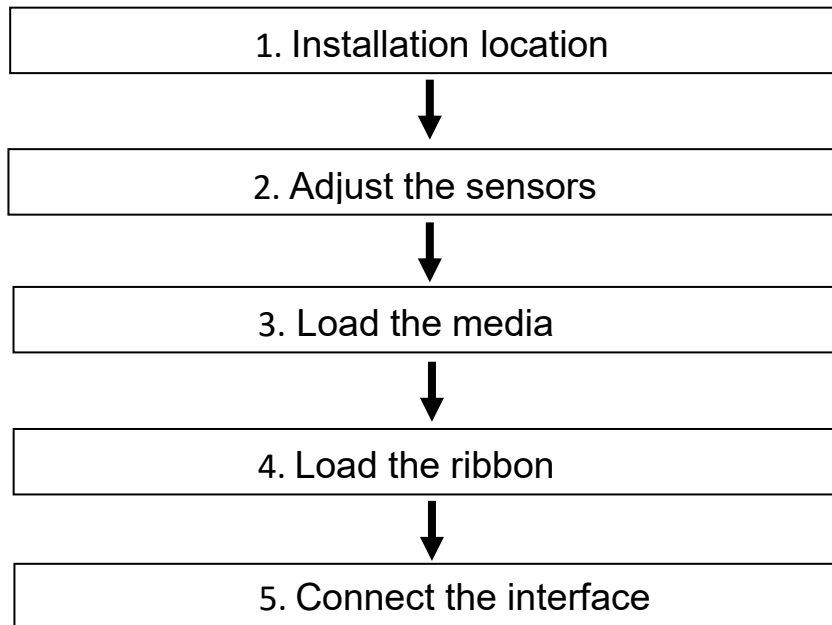

### 2.2 Suitable Installation Site

Consider the following factors to choose the site to install the printer:

1. Install the printer on a solid, level and stable workbench surface.
2. Sufficient space around the printer to provide good ventilation, stack the printout, access the control panel, replace the ribbon/media, and carry the maintenance.
3. Avoid heat and damp sources.
4. Avoid an environment close to vibration and shock.
5. Ensure the power source is securely grounded.

## 2.3 Connect the Power



Important: Check the voltage rating of the power source complies with that of the printer; incorrect voltage of the power source may cause hazard and damage the printer.

1. Switch off both the PC and the printer.
2. Connect the connector of the detachable cable to the printer power socket.
3. Connect the power plug to the wall socket.
4. If media and ribbon are installed, toggle the power switch to ON position to turn on the printer and the power LED will light up.

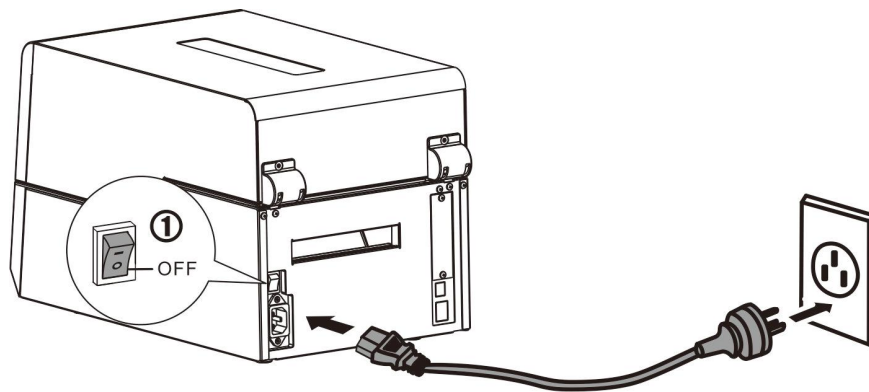

Important:



1. Hold the power plug to unplug the power.
2. Pulling the power cord by force to unplug the power may break the power cord causing fire and electric shock.
3. Turn off the power if the printer is not in use for long period.

## 2.4 Adjust the Media Sensors

### 2.4.1 Two Types of Media Sensors

The printer makes use of the media sensors to register the media to a precise position relative to the print head. You should activate the correct sensor for your media in use:

1. Gap sensor: for labels or tickets & tags - with a gap or notch separating consecutive media.
2. Black mark sensor: for receipts/tickets - with pre-printed black stripes on the back.

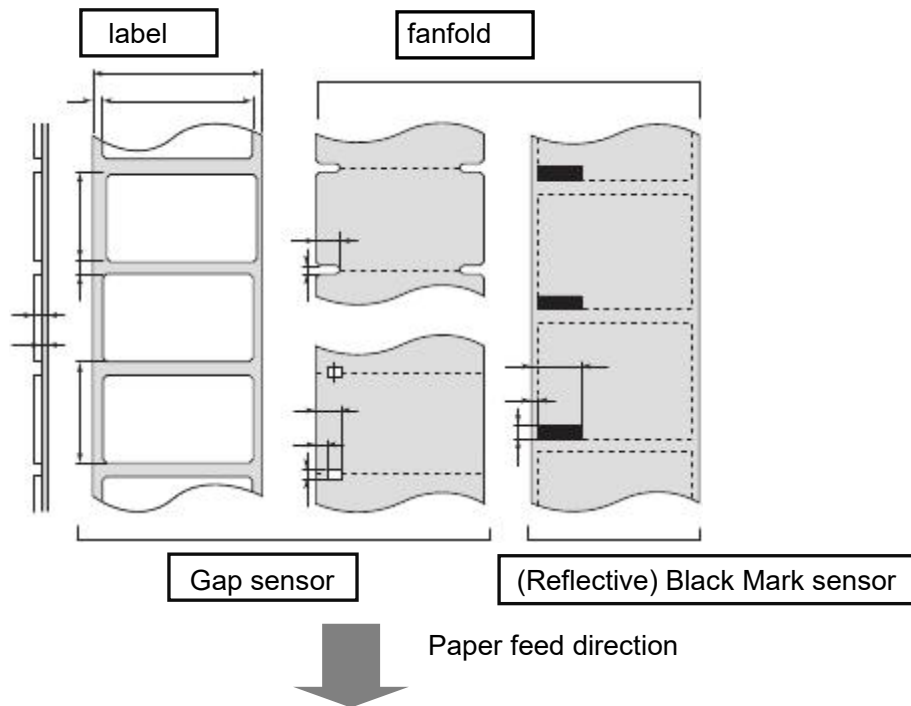

Only one media sensor can be active at anytime. According to the media in use, activate the appropriate sensor under the System Setup menu from the Control Panel or the Config Tool. Read [Sections 2.4.2](#) and [2.4.3](#) to relocate the sensors according to the media width in use.

### 2.4.2 Relocate the Gap Sensor

When printing labels or ticket & tag media, activate Gap Sensor in the System Setup menu from the Configuration Tool or Control Panel. Additionally, relocate the sensor position to match the media width in use:

1. Open the top cover and unlock the print head.
2. Load new media. (Read Section 2.5.)
3. For labels with liner, move the Black Mark Sensor to a position within the physical label. If use media with notches, move the Black Mark Sensor underneath a notch.
4. See below photo. Align the two triangular markers on the Gap Sensor and Black Mark Sensor.

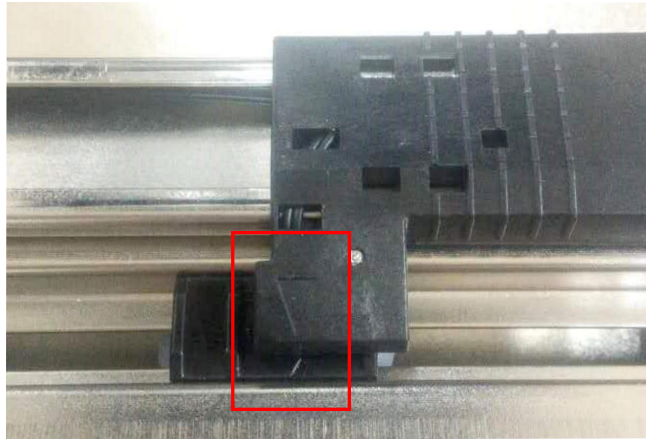

### 2.4.3 Relocate the (Reflective) Black Mark Sensor

When printing media with black marks or black lines on the back, activate the Black Mark Sensor in the System Setup menu. Additionally, relocate the sensor position to match the media width in use:

1. Open the top cover and unlock the print head.
2. Load new media. (Read Section 2.5.)
3. See below photo. Move the Black Mark Sensor directly underneath the black mark of the media.
4. Move the Gap Sensor beyond the Black Mark Sensor; otherwise, the printer fails to detect out of media.

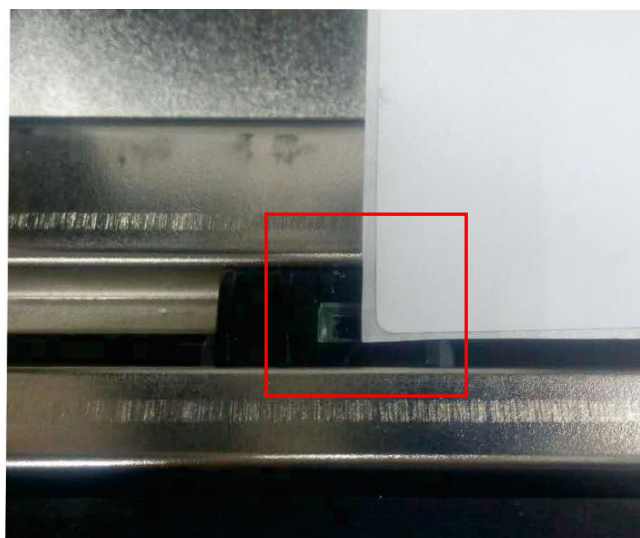



## 2.5 Load the Media

### 2.5.1 Loading Procedures



Please identify if the media requires a ribbon. Only temperature sensitive media do not require ribbons.

Caution: To prevent media jam, always align the media to the left side of the printer.

If dark tracks do not come out by scratches on the media surface, the media is not temperature sensitive and a ribbon is required.

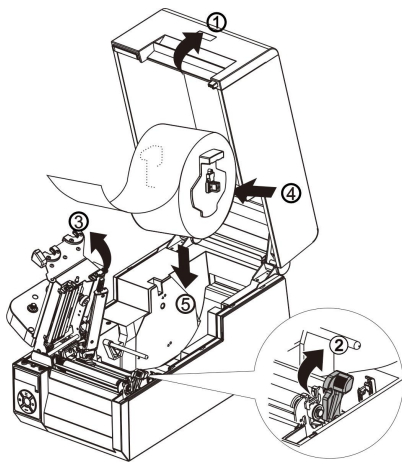

1.

① Open the top cover.

② Push the blue Release Lever to release the head module.

③ Lift the Sensor Arm.

④ With the printing surface facing up, clam the media roll between the Media Holder and the Media Width Adjuster.

⑤ Load the clammed roll into the media compartment.

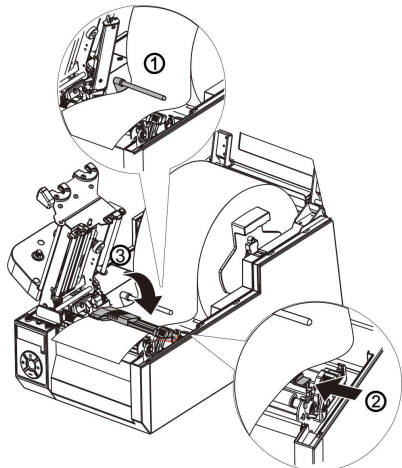

2.

① Route the media underneath the Damper.

② Move the Right Media Guide to fit the media width.

③ Return the Sensor Arm to its original position.



Important: The printing surface faces upward.

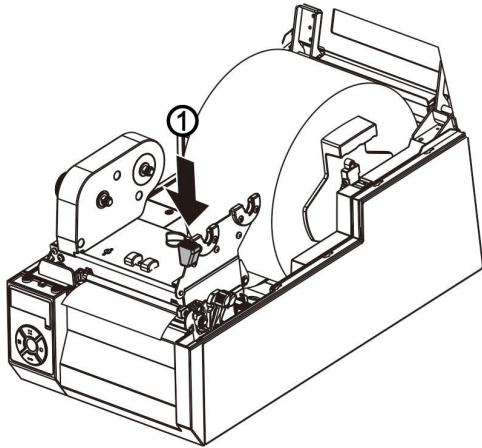

3.

- ① If new media, read Section 2.4.2 or 2.4.3 to relocate the media sensors.
- ② Push the blue Engage Handle to lock up the print head module.

4.

Making a media calibration ensures the printing starts with the correct position on the fresh media. Hold the ►► button and then turn on the power. After the beeper sounds twice, release the button to complete the media calibration process.

---

Make media calibrations for the following situations:



A fresh media.

A media with different size from the last print task.

Blank printout from in-used media.

Offset printout without changing the settings.

---

### 2.5.2 Adjust the Media Thickness and Width

It is important to set correct thickness and width for media to improve the print quality.

- When every printout is poor in quality, the thickness is incorrect.
- When the printout is poor only on one side, the width is incorrect.
- When printing on thick media like tags, test the print quality with incremental thickness values.
- After replacing different size media or direct thermal media, test print quality with incremental width values.

#### (1) Adjust the media thickness

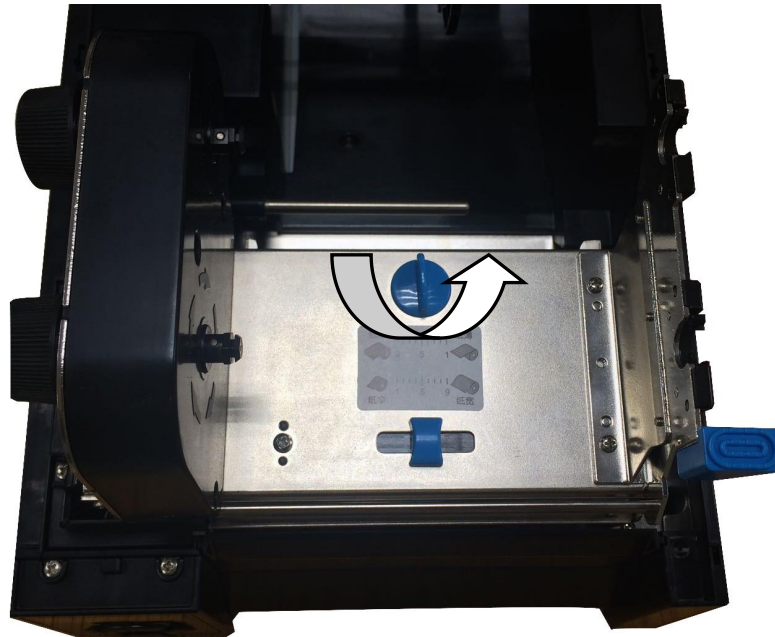

Recommended Dial Positions	Media
1-2	Direct thermal rolls, general labels
3-5	Labels with thick liner
6-9	Thick media like tags or tickets

Above are just recommended settings for different media. Verify the setting with your test results.

The ex-factory setting is 1-2. (The default thickness for general labels.)

Please note that the combination of media thickness and hardness of the media may cause slight variation.

Adjusting the thickness may resolve the problem of wrinkled ribbon.

#### (2) Adjust the media width

Adjusting the position of the Media Width Slider applies an even pressure on the print head across the media width. When the printout is lighter on one side or crook print media, adjust the Slider with different positions.



Caution: Must adjust the slider position to avoid jammed media causing head damage when narrow width media is used.

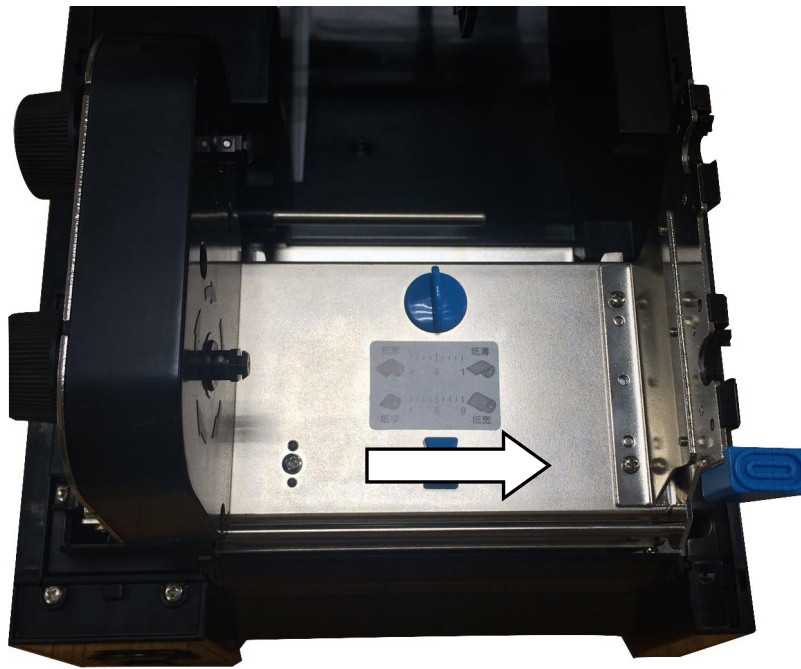

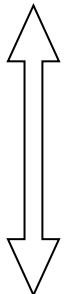
Recommended Slider Positions	Media width mm (inches)	Head Pressure
1	19.5 ~ 30.0mm(0.77 ~ 1.18)	<div style="text-align: center;">           Low              High         </div>
2	30.0 ~ 39.0mm(1.18 ~ 1.53)	
3	39.0 ~ 49.0mm(1.53 ~ 1.92)	
4	49.0 ~ 62.0mm (1.92 ~ 2.44)	
5	62.0 ~ 76.0mm (2.44 ~ 2.99)	
6	76.0 ~ 88.0mm(2.99 ~ 3.46)	
7	88.0 ~ 99.0mm(3.46 ~ 3.89)	
8	99.0 ~ 108mm(3.89 ~ 4.25)	
9	108 ~ 118mm(4.25 ~ 4.65) (default setting)	

The above table states the standard setting for general situation.

Adjust the Slider and make test prints when thick media are used or wrinkled ribbon occurs.

## 2.6 Load the Ribbon

### 2.6.1 Loading Procedures

If dark tracks do not come out by scratches on the media surface, the media is not temperature sensitive and a ribbon is required.



Note: Ribbons are required to print on non-thermal-sensitive media.



Using ribbon to print on thermal media produces poor quality graphics and bar-codes.

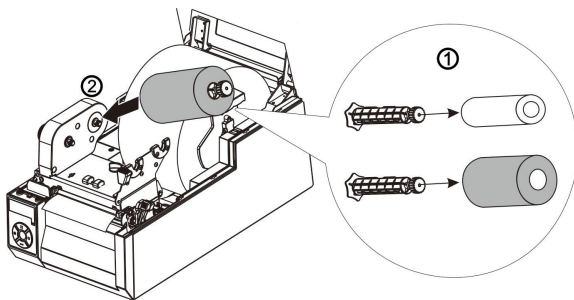

1.

① Insert the two Ribbon Spindles into the Ribbon Core and new ribbon roll.

② Plug the Spindle loaded with ribbon onto the rear driving shaft of the Ribbon Drive module.

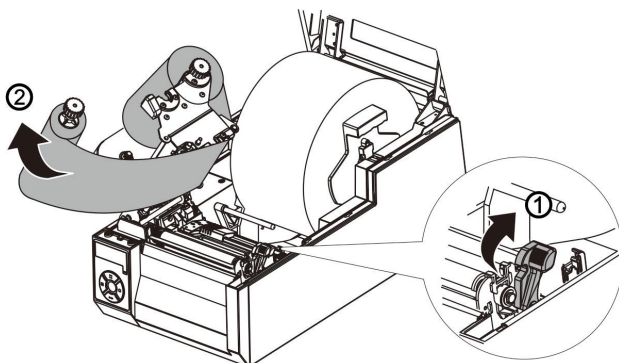

2.

① Push the blue Release Lever to release the head module.

② Pull the ribbon and fix the end to the Ribbon Core. Spread the middle portion of the ribbon evenly over the print head. Plug the Spindle, loaded with the Ribbon Core, onto the front driving shaft of the Ribbon Drive module.

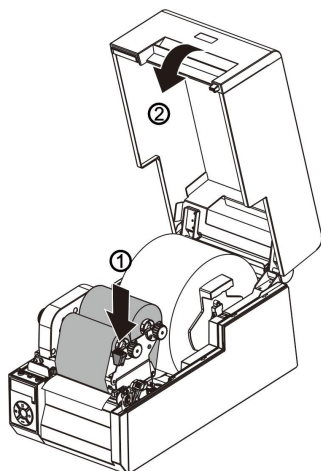

3.

① Turn the Spindles to wind up excess ribbon. Push the blue Engage Handle to lock up the Print head module.

② Close the Top Cover.

### 2.6.2 Resolve the Wrinkled Ribbon by Adjusting the Ribbon Balance Gear

When you observe loose ribbon on one side from the front or wrinkled ribbon, adjust the Ribbon Balance Gear resulted in even ribbon tensions on both ends.

1. Unfasten the shaft screw.

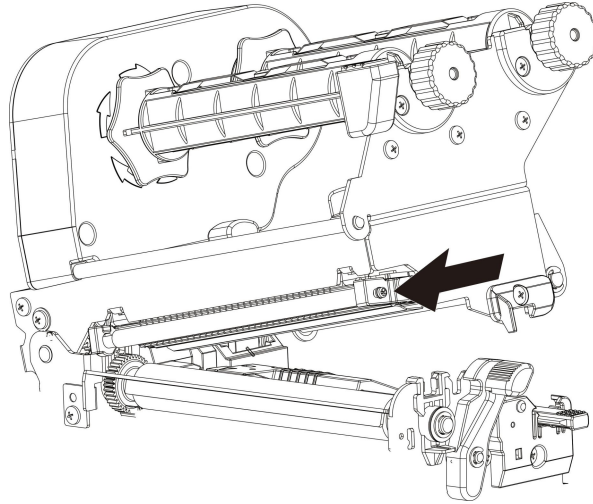

2. Turn the Ribbon Balance Gear to shift the shaft slightly forward or backward.

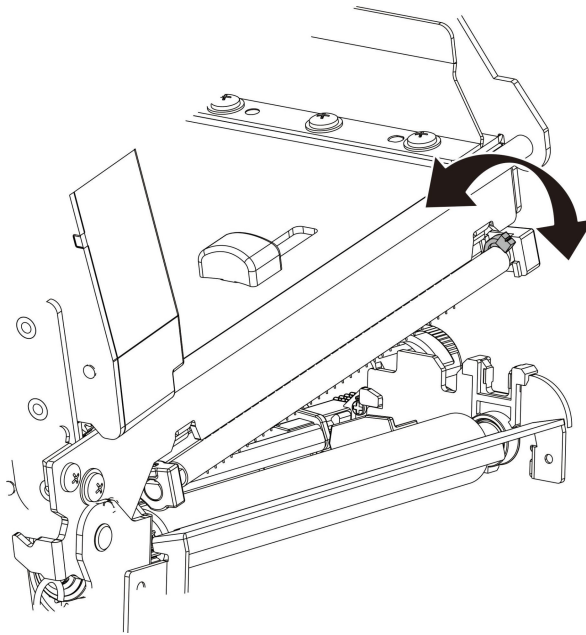

3. After the adjustment, tight up the shaft screw.

### 2.6.3 Resolve the Wrinkled Ribbon by Adjusting the Ribbon Supply Leveler

When you observe loose ribbon on one side from the supply side or wrinkled ribbon, adjust the Ribbon Supply Leveler resulted in even ribbon tensions on both ends of the supply side.

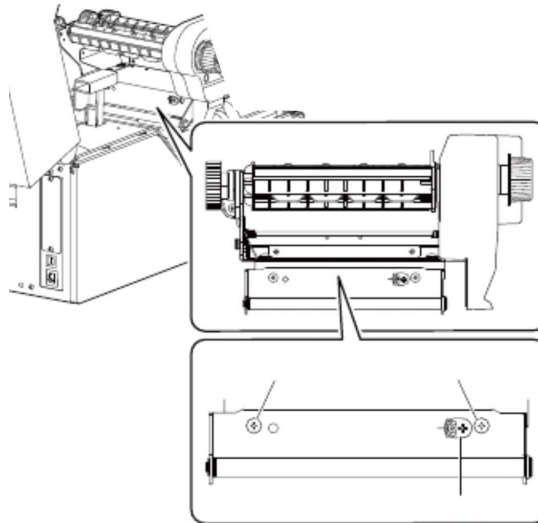

- (1) Unfasten the two screws fixing the metal plate.
- (2) Unfasten the screw fixing the Leveler.
- (3) Turn the Leveler to change the tilt angle of the metal plate and its shaft, which is in contact with the supply ribbon..

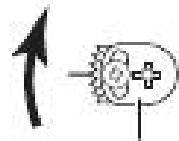

Clockwise to tilt the shaft upward.

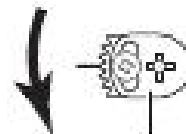

Anticlockwise to tilt the shaft downward.

- (4) When you observe balance tensions on both ends of the supply ribbon, fix all 3 screws.
- (5) Repeat the adjustment if you find wrinkle ribbon after fixing the screws.

**NOTE:** Incorrect media thickness and width settings may cause wrinkle ribbon as well. If several attempts on Leveler adjustment fail to correct wrinkle ribbon, you should check the media thickness and width settings.

## 2.7 Connect the Interface

This printer provides USB and LAN interfaces for standard shipment. Parallel option is available. You may decide to install additional interface to the backside of the printer.

The procedures to connect the standard interface:

1. Disconnect or switch off the power supplied to the printer.
2. Plug in one end of the interface cable to the corresponding interface port.
3. Plug the other end of the cable to the PC port.

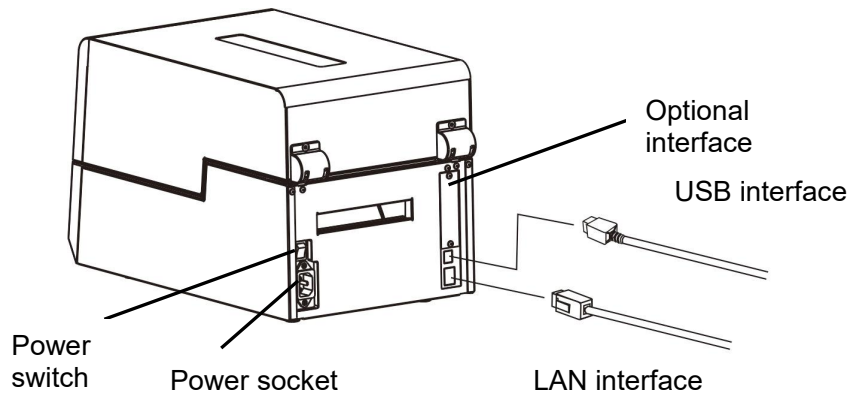

Parts	Descriptions
Power socket	Connect to the connector on the power cord.
Power switch	Toggle it to turn the printer on or off.
USB interface	Communicate with the PC via USB connection. (standard interface)
LAN interface	Communication with the LAN server. (standard interface))
Optional Interface	Reserve for the installation of option: parallel

Requirements for interface cables:

To prevent radio emission and interference, completely shielded cable with conductive connector housing should be used. Consider the following factors to reduce emission/interference levels:

- Use short interface cables. (Less than 1.5 m in length is recommended.)
- Separate the interface cable from the power cord.
- Avoid routing the interface cable within the power duct.



## CHAPTER 3 SOFTWARE INSTALLATION

### 3.1 Installing the Driver

The driver is the connection and transformation platform between the printer and the computer operating system to achieve the interactive processing of the information. User can set up relevant settings, get print status and etc. via driver.

The latest Windows printer drivers can be downloaded from our web:

<https://www.dascom.com/downloads.html>

From the folder that you unzipped the driver files to select “Install.exe”. The program will guide you to finish the whole installation.

(1) Click “Next”.



(2) Select the driver model and a port, Click “Next” button to continue.

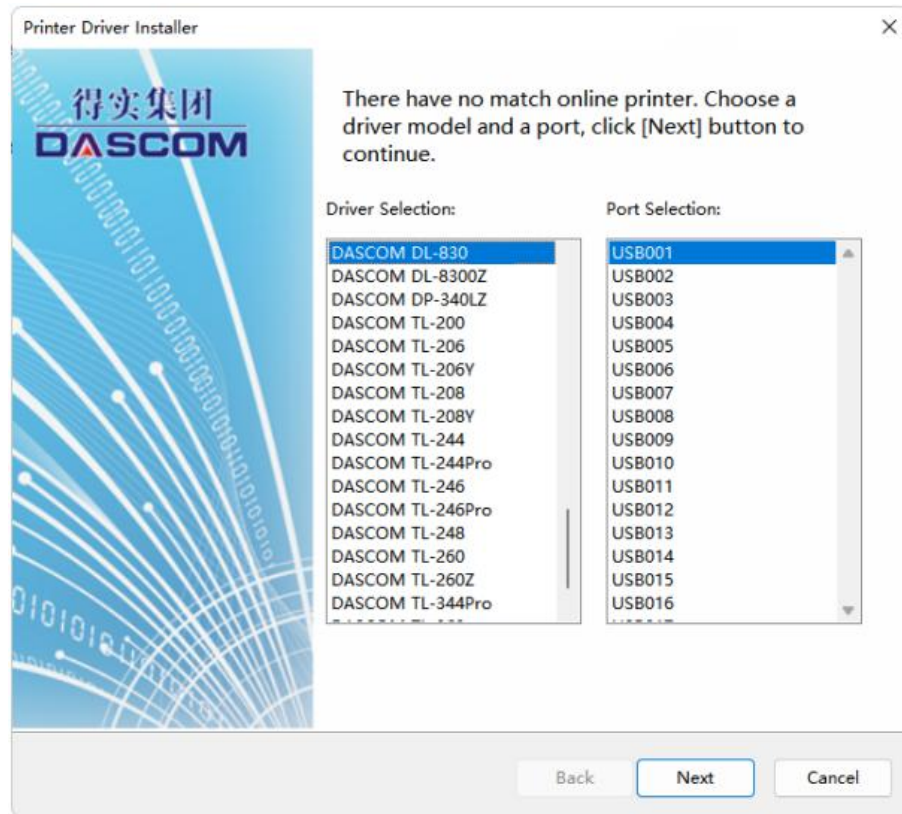

(3) Set up the printer name, click “Start”.

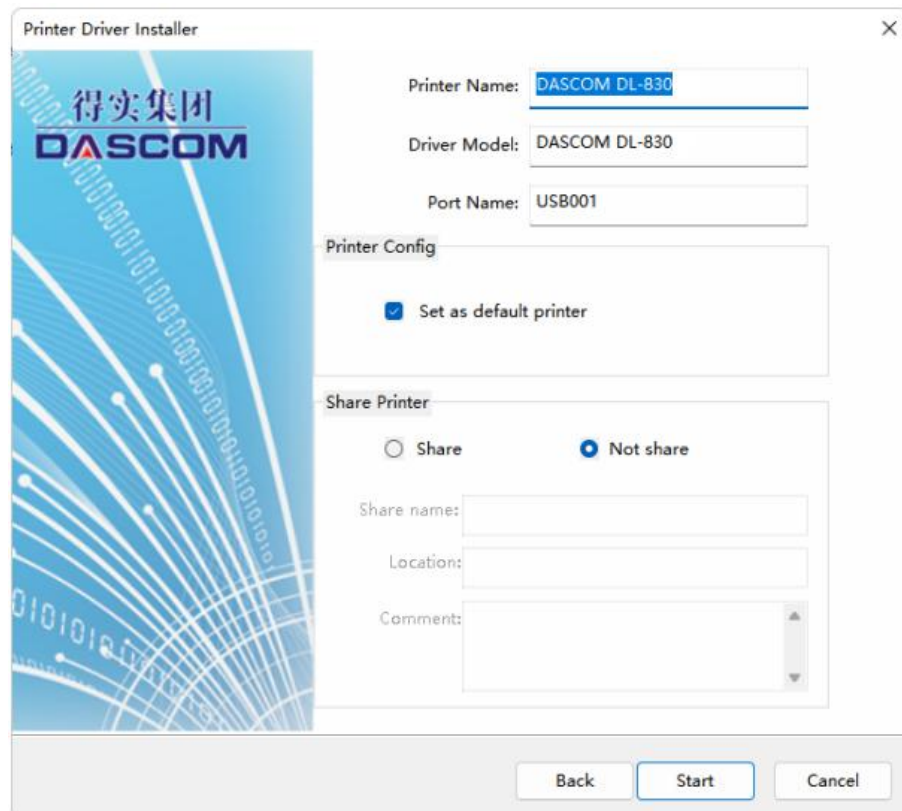

(4) Wait for the installation to finish.

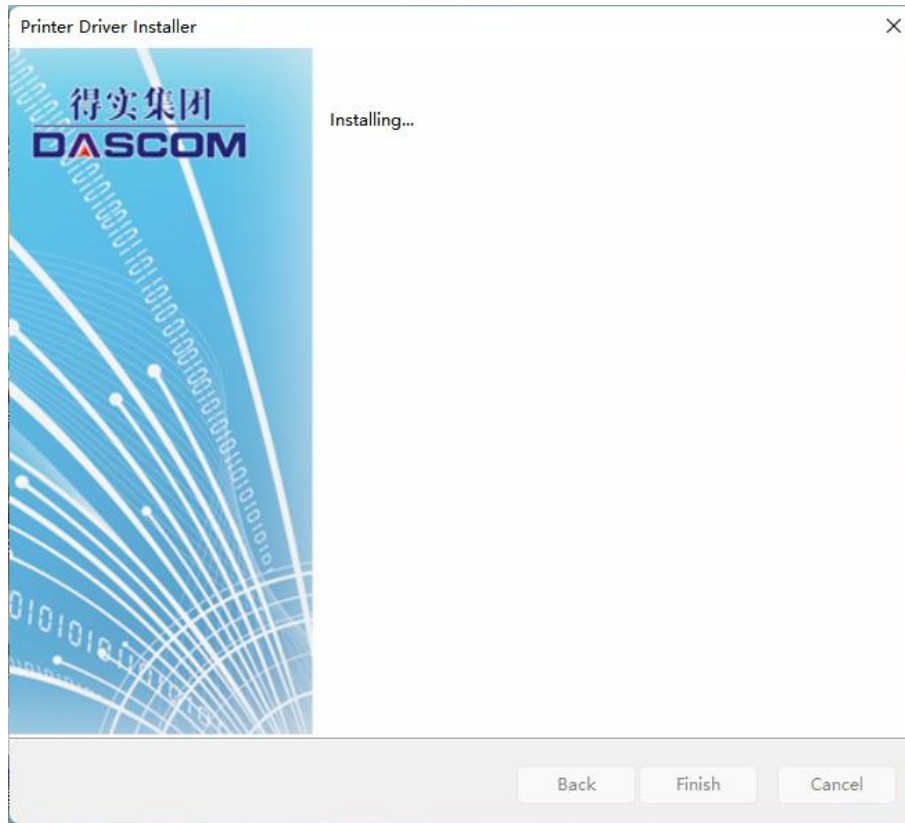

(5) Click the Finish button once the installation ends.

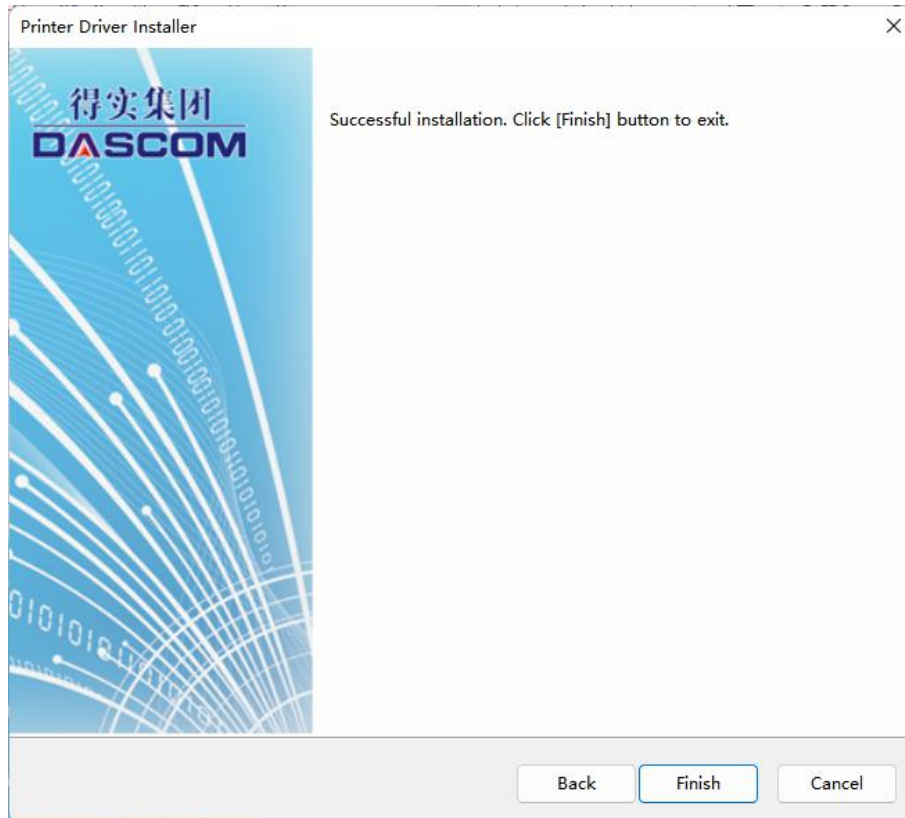

### 3.2 Installing the Configuration Tool

The Configuration Tool package can be downloaded from our web:  
<https://www.dascom.com/downloads.html>

- (1) Specify the installation folder. Then click **Next**.

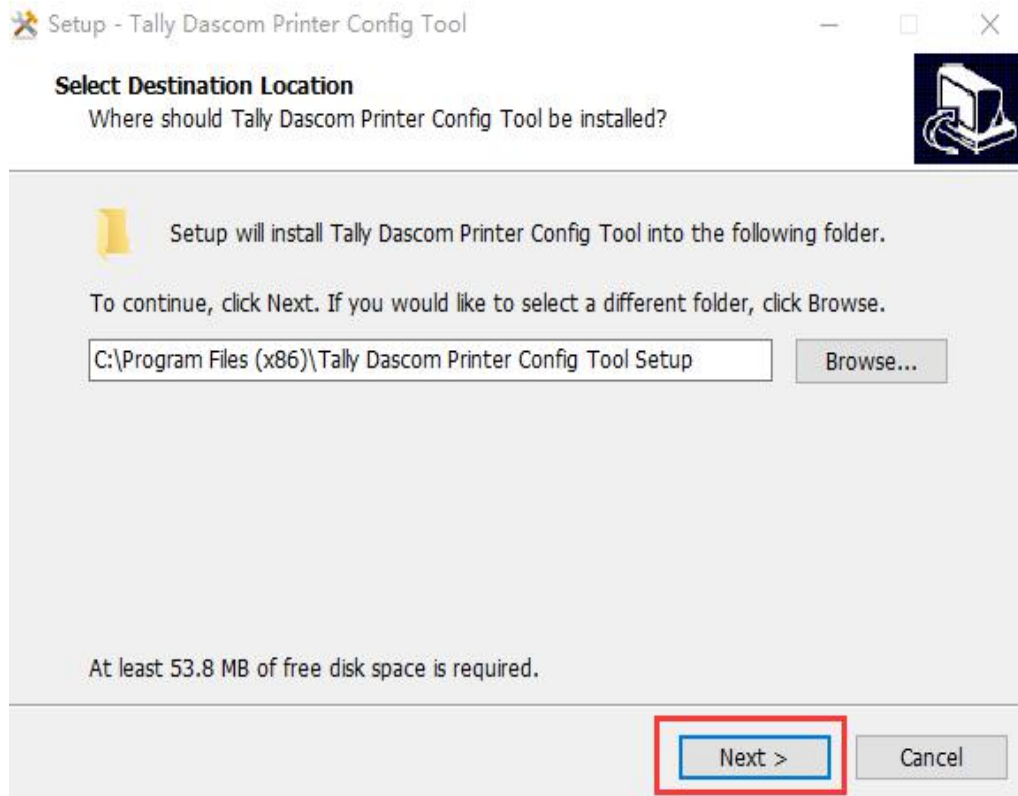

- (2) Decide if you want to create a Start Menu folder. Then click [Next](#).

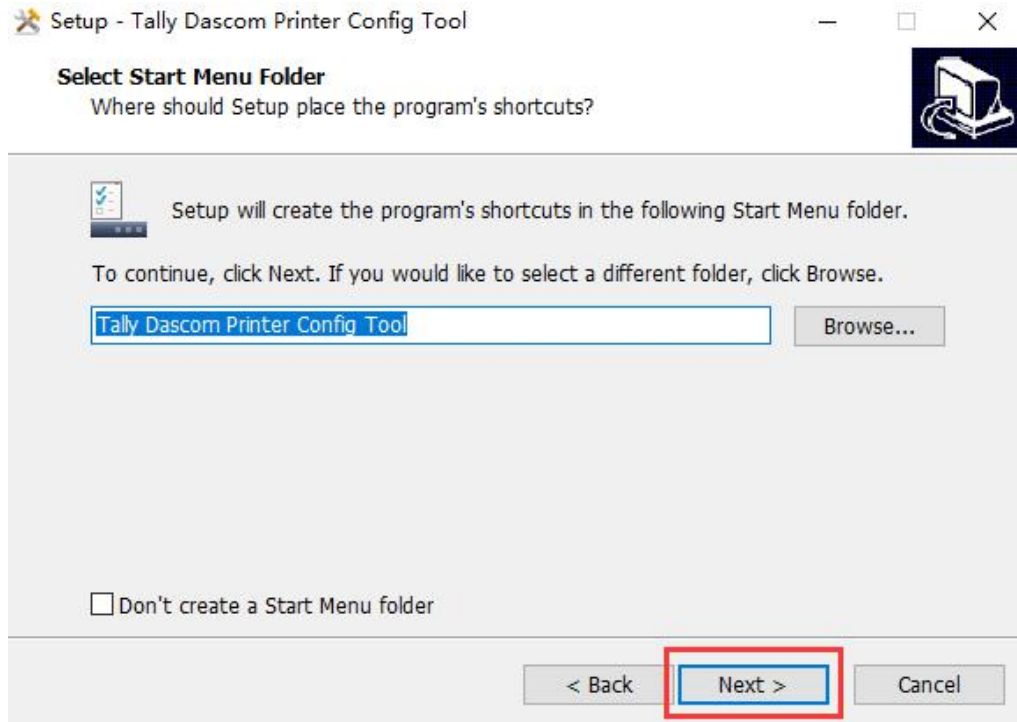

- (3) Decide if you want to create a desktop shortcut for this Configuration Tool.

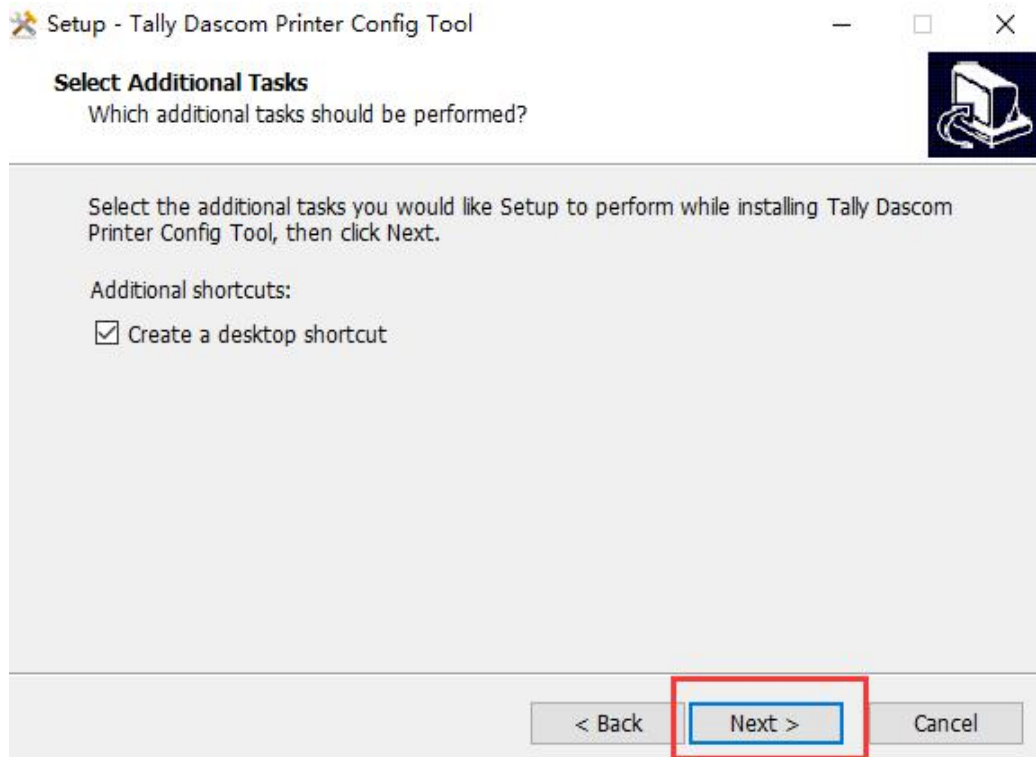

- (4) Confirm the installation information. Click [Install](#) to proceed.

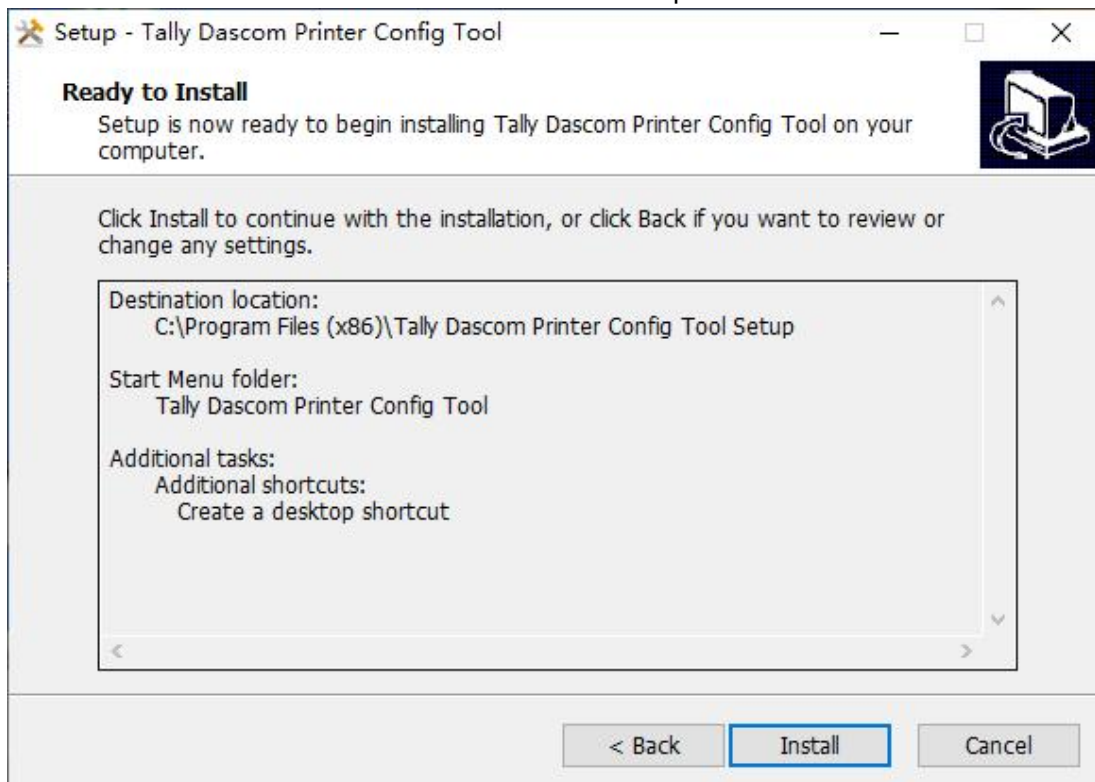

- (5) The Configuration Tool is successfully installed. Click [Finish](#).

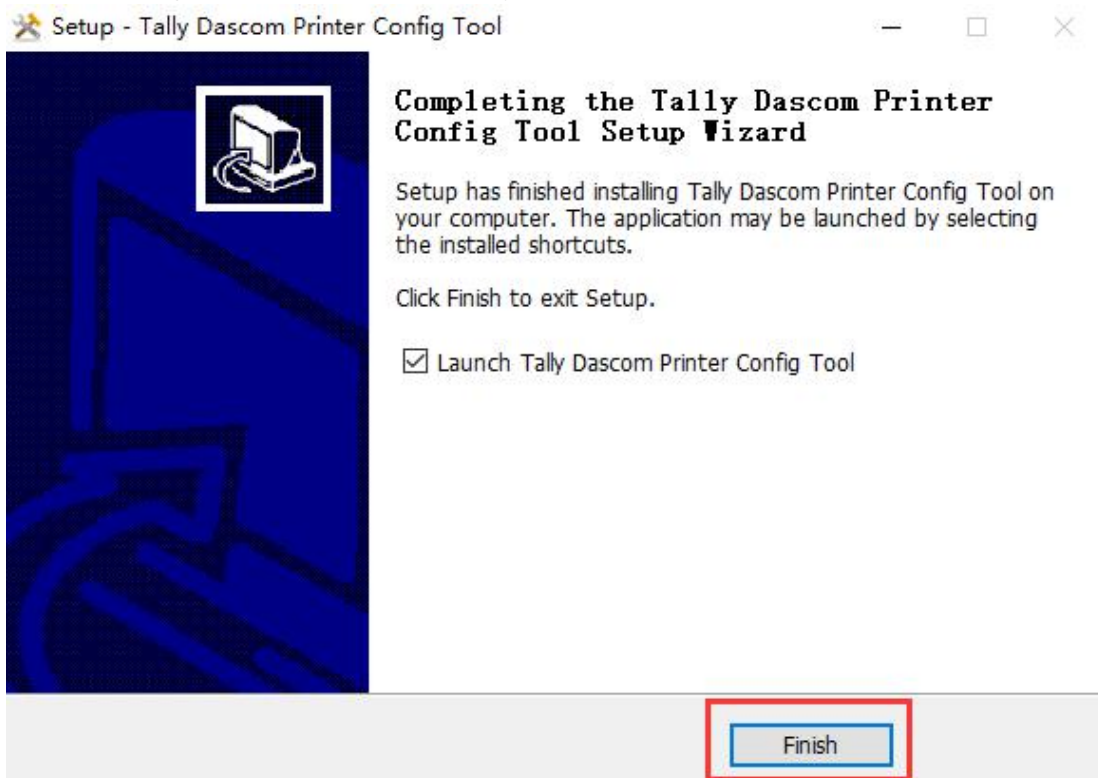

### 3.3 Config Tool “Connect” Setup Process

After the installation is successful, start the Program -

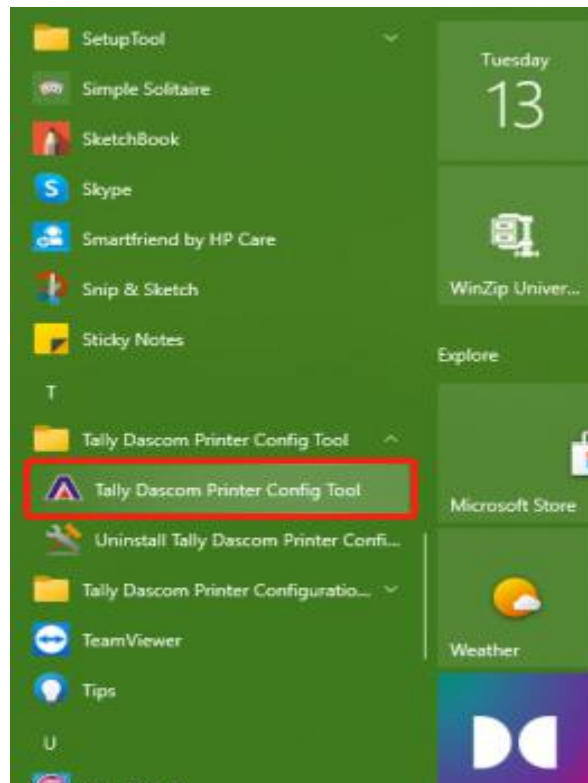

(1) Config Tool Start up Page -

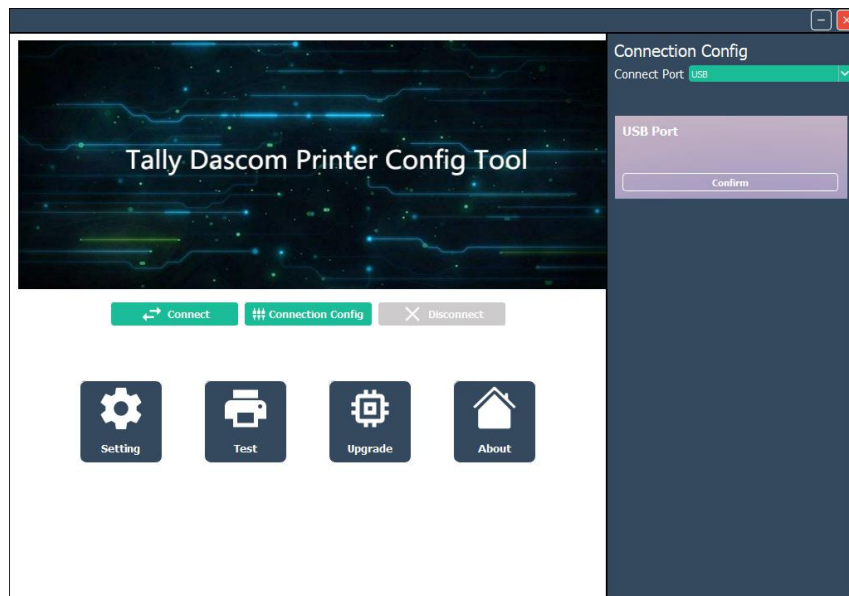

(2) Use **Connection Config** to select the I/O being used to connect to the Printer, USB, Serial, Parallel or Network.

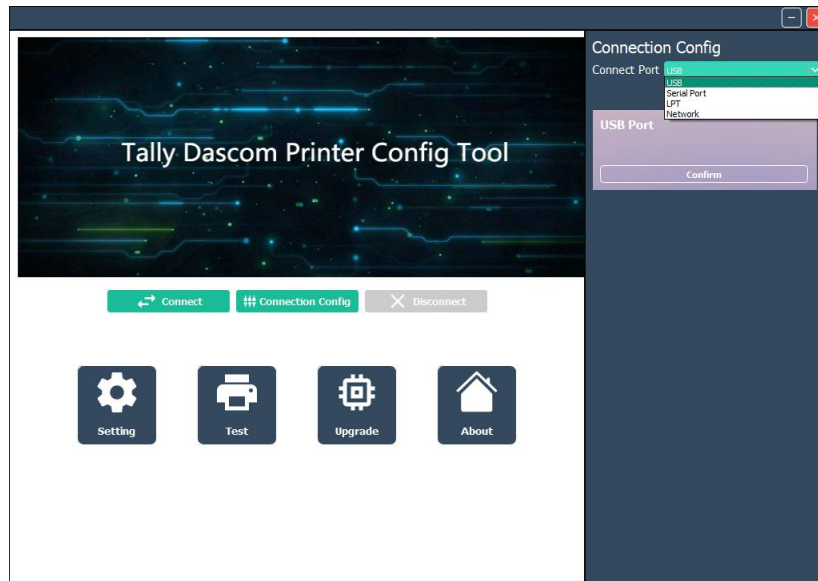

(3) Serial Port settings need to be set/configured to the Host Serial settings.

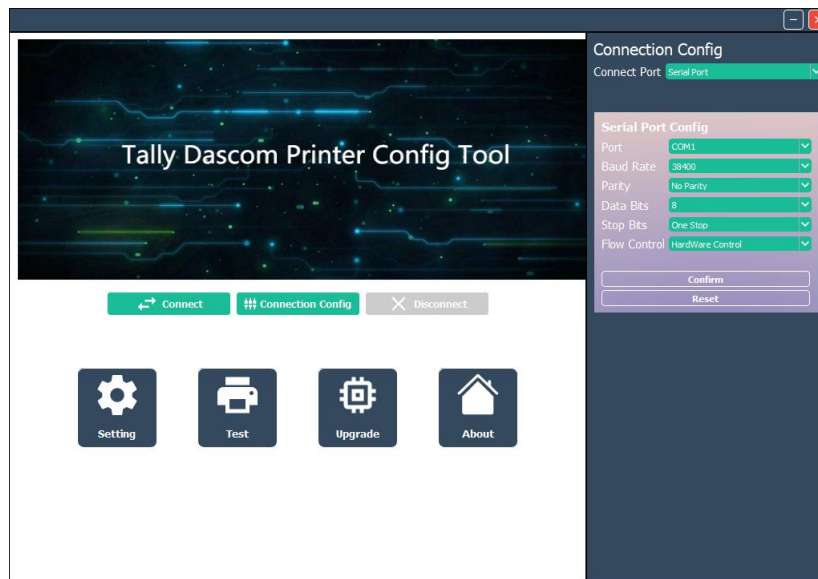



(4) Set the Parallel port setting to match the LPT port used on the PC -

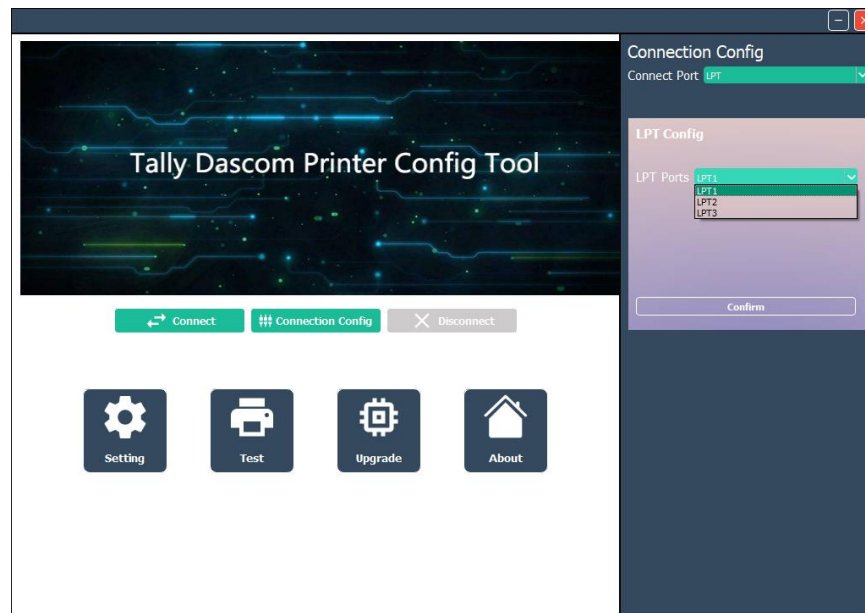

(5) Network configuration by adding the Printers assigned IP Address –

Once the proper I/O type has been selected, click on the Confirm button

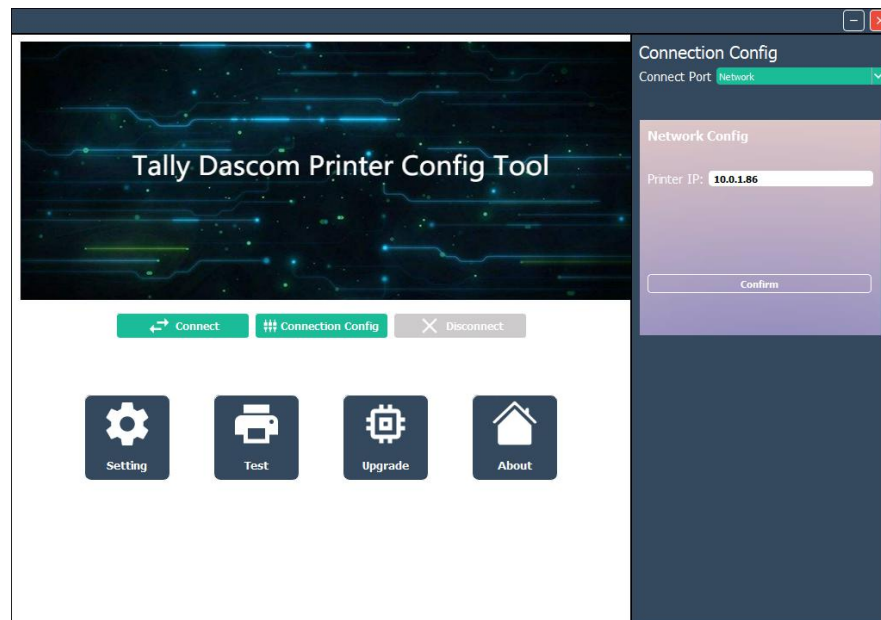

(6) The Tool will try to reach the Printer and if the I/O Port information is set up properly the Tool will connect.

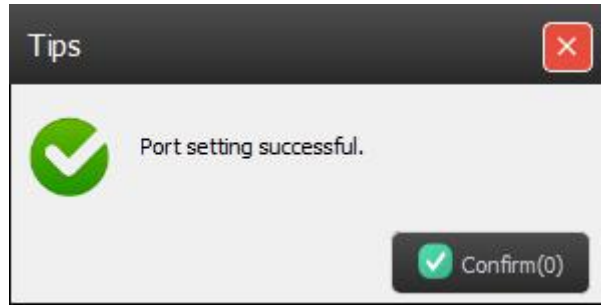

( 7 ) Verified I/O Connection is made because the Tool now displays the Printer statistics under Printer Info -

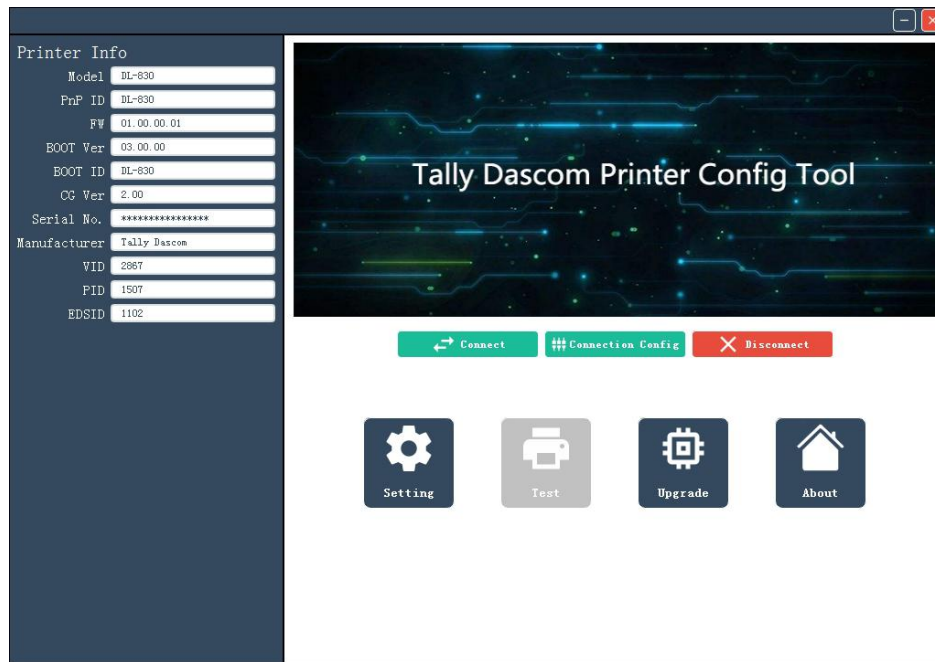

### 3.4 Using the Configuration Tool

You can conveniently setup the printer for your application or upgrade the firmware with this Configuration Tool.

#### 3.4.1 Setup for the Media with Black Marks

In Config Tool, click **Connect**; then click **Setting**. Select **Reflective** for **Paper Sensor** to support media with black marks.

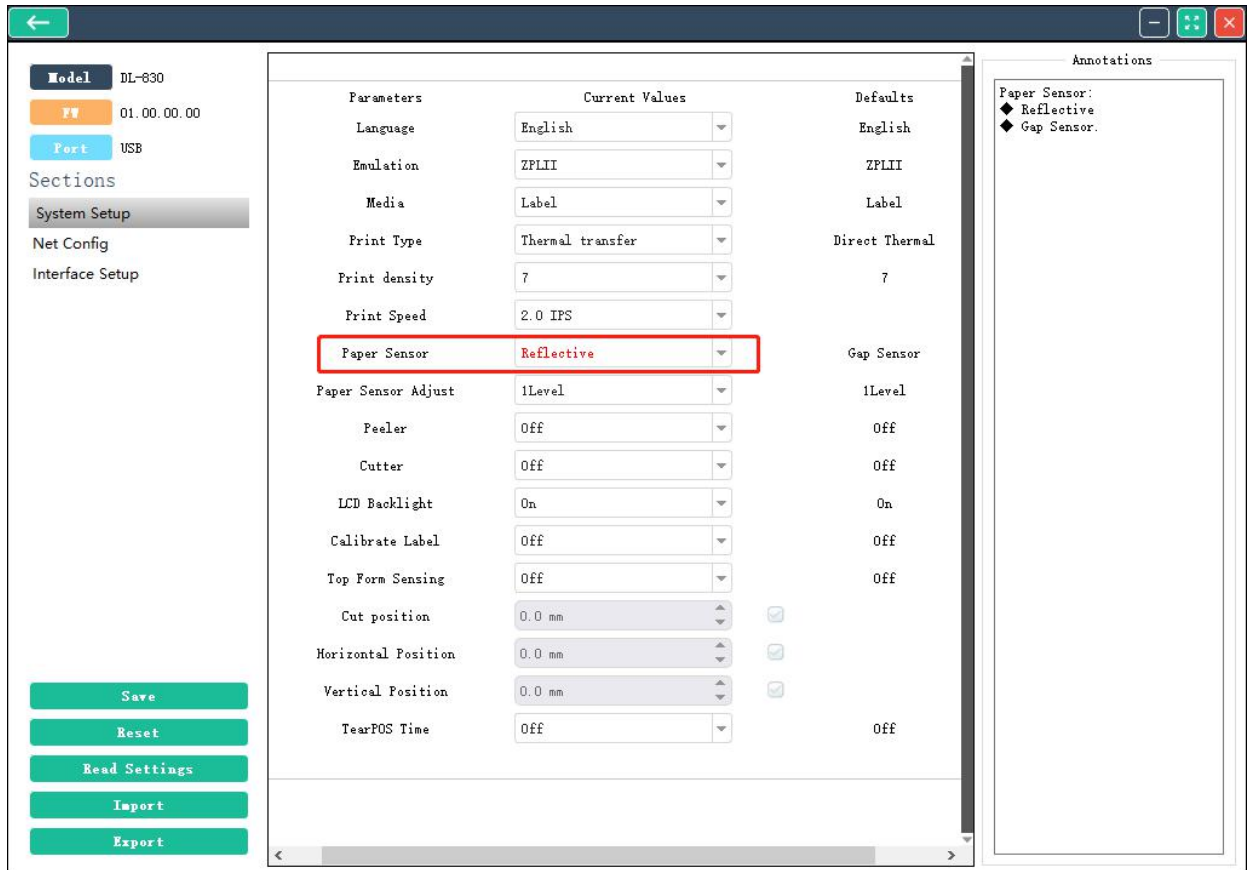

When you use the media with notches between labels, select the [Gap Sensor](#).

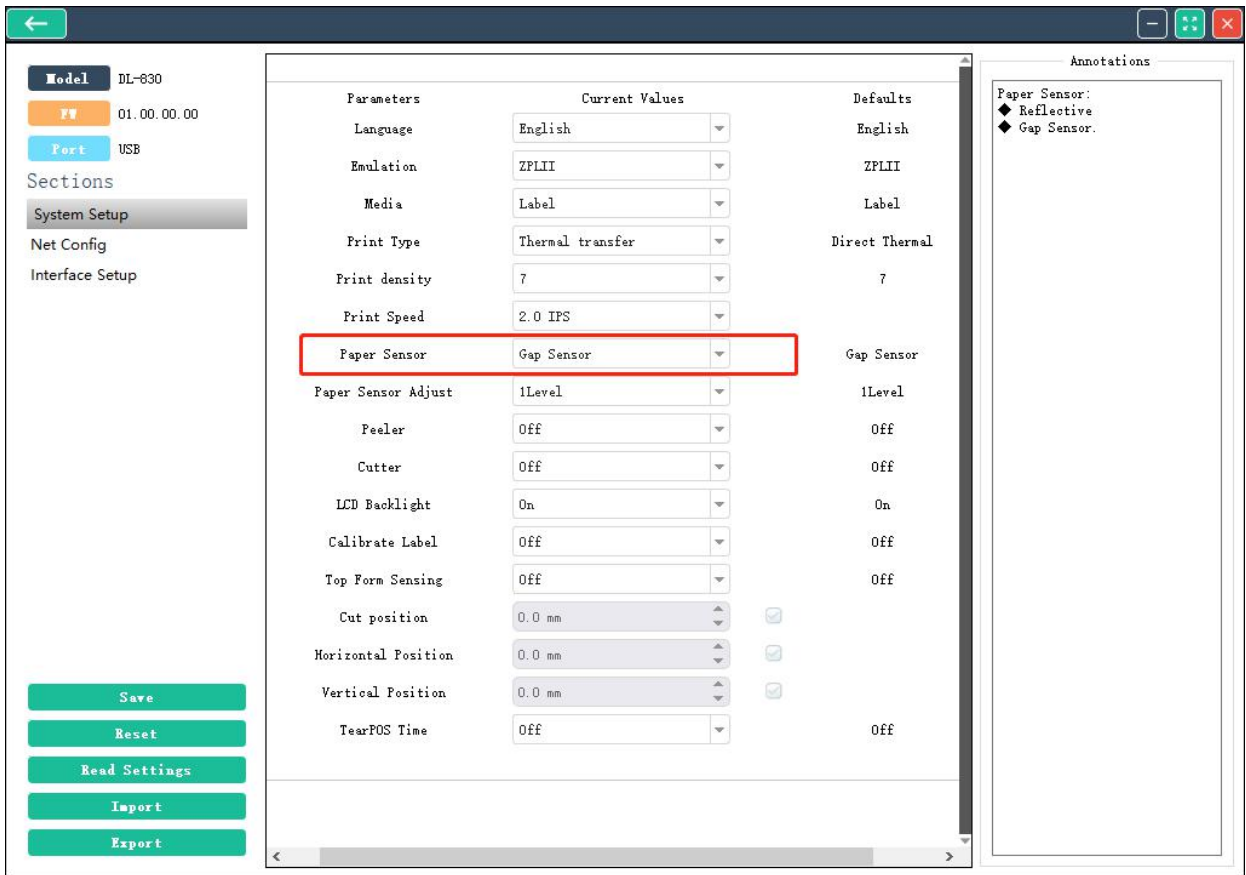

### 3.4.2 Setup for the LAN Connection

In Config Tool, click [Connect](#); then click [Setting](#). Select [Net Config](#).

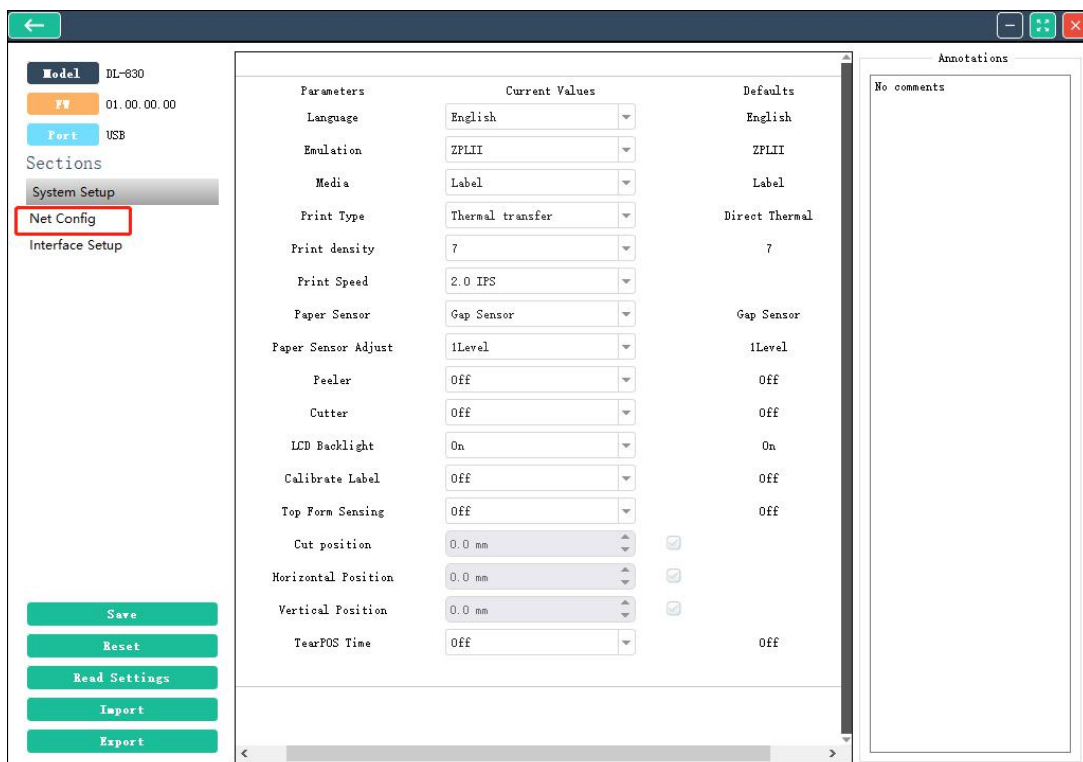

Fill in the LAN information and then click [Write](#).

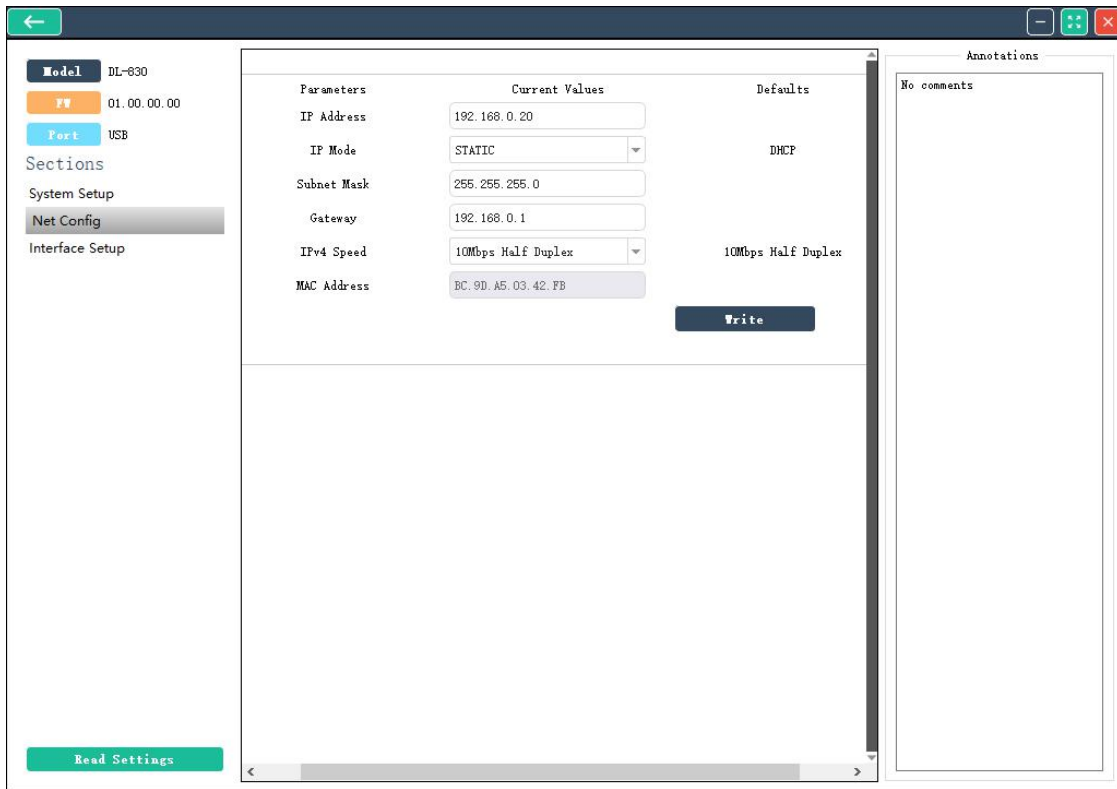

### 3.4.3 Setup for the WiFi

In Config Tool, click [Connect](#); then click [Setting](#). Select [WiFi setup](#).

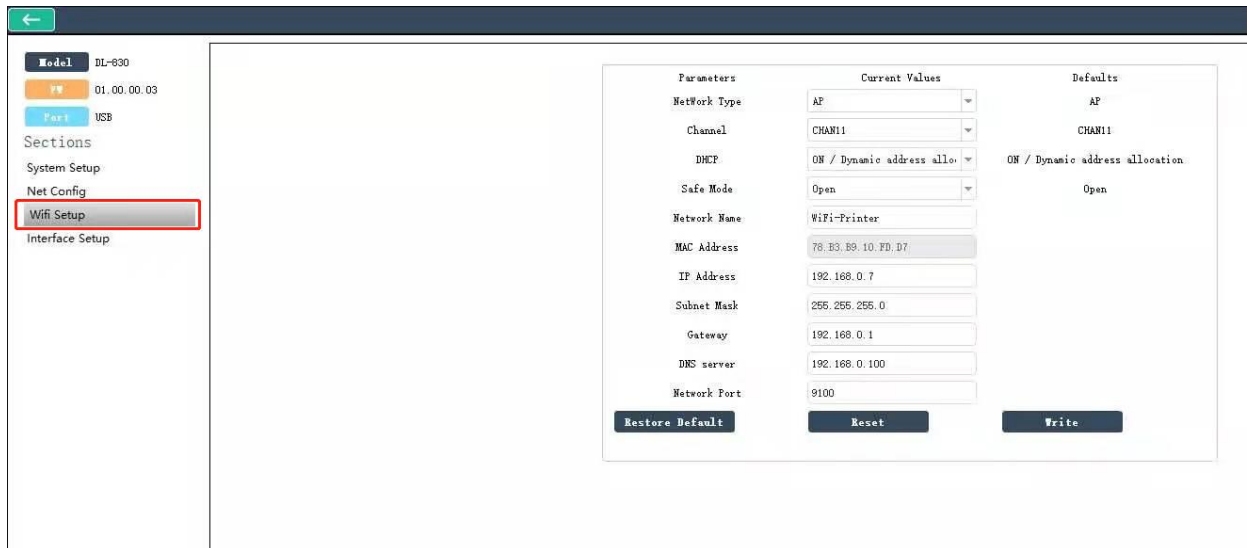

### 3.4.4 Setup for the Interface

In Config Tool, click [Connect](#); then click [Setting](#). Select [Interface setup](#).

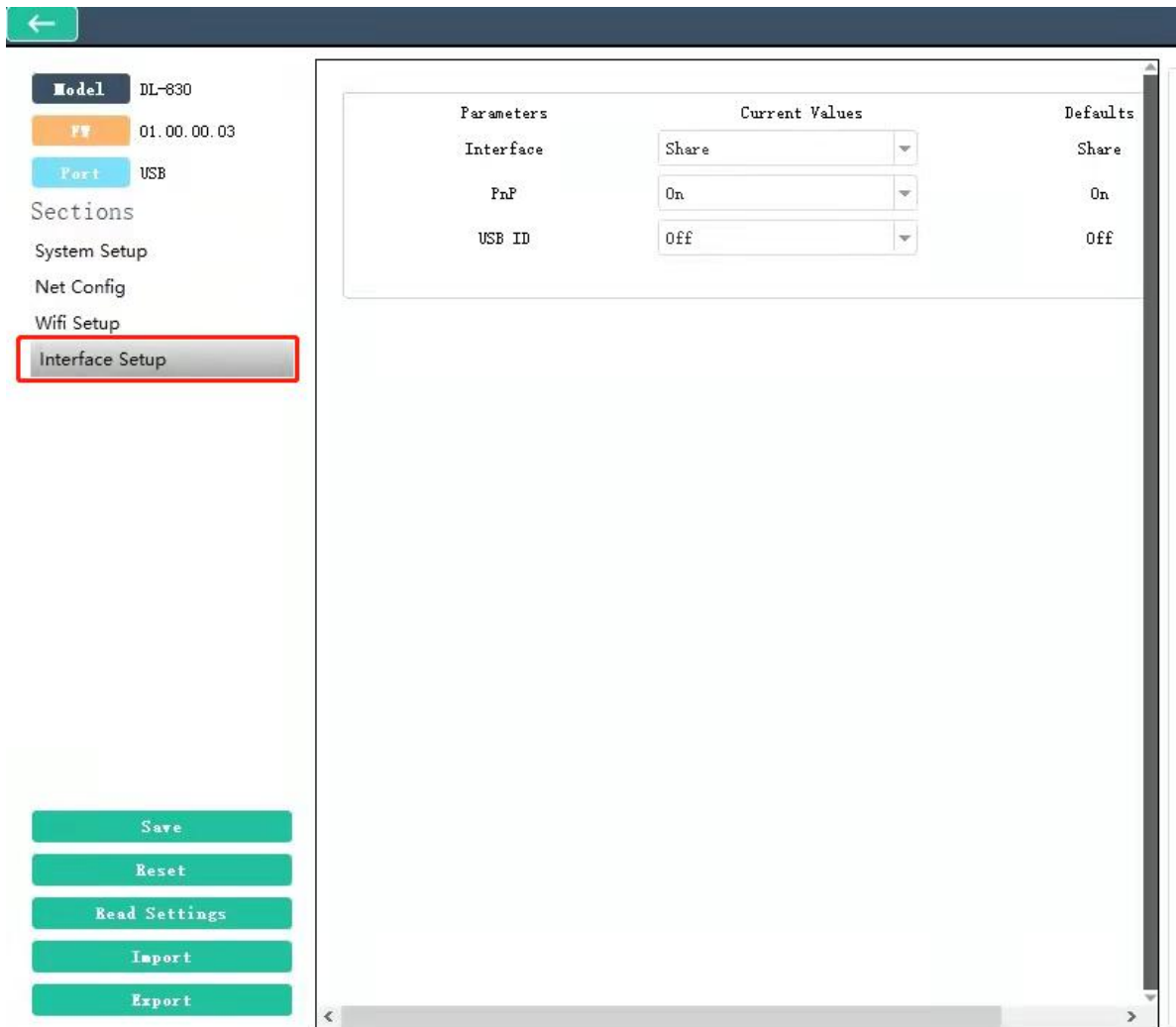

### 3.5 Upgrading the Firmware

- (1) Connect the printer to the PC with an USB cable. Click [Upgrade](#) in the Config Tool menu.

Notification:  
Printer is about to enter the firmware download mode.  
Please ensure power is not disrupted.  
Make sure the interface cable is correctly connected between the computer and the printer.  
During the update, do not power off the printer.  
During the update, please stop all the printing tasks.  
During the update, please wait patiently, until the download progress reaches 100%.  
Note: Do not close page during download!

Firmware Update

[Browse](#)

[Start](#)

- (2) Locate the firmware file by clicking [Browse](#). Then click [Start](#). A message box pops up to ask for confirmation; click [Confirm](#).

Notification:  
Printer is about to enter the firmware download mode.  
Please ensure power is not disrupted.  
Make sure the interface cable is correctly connected between the computer and the printer.  
During the update, do not power off the printer.  
During the update, please stop all the printing tasks.  
During the update, please wait patiently, until the download progress reaches 100%.  
Note: Do not close page during download!

Firmware Update

[Browse](#)

[Start](#)

- (3) When the progress bar reaches 100%, the upgrade process is completed and the printer will be restarted.

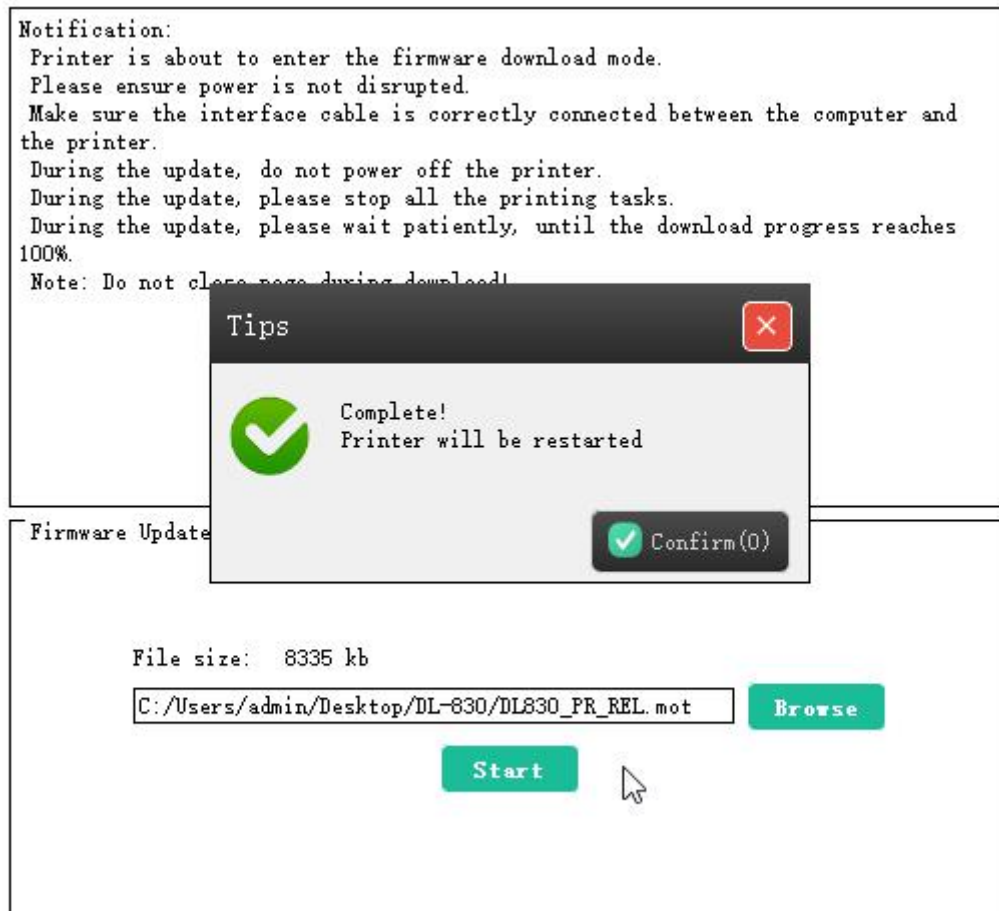



## CHAPTER 4 SUPPORT UTILITIES

### 4.1 Configuration List (Self-test Page)

Listing the configurations helps to confirm the printer is properly setup. The procedures to print out this configuration list:

1. Properly load the media. Close the top cover. Turn off the power.
2. Hold the ►► button when turn on the printer.
3. Release the ►► button after the power LED flashes once and the buzzer beeps once. The printer then prints out the configuration list.

```
【Machine information】
Model: DL-830
ManuFact: Tally Dascom
FW Ver: 01.0A.00.04
BOOT Ver: 01.01.00
FPGA Ver: 00.FF.FF
HD Ver: 3.0
NET Ver : 01.00.00.00
FW Time: Mar 19 2021
Machine Num: 455420030281
【System Setup】
Language: English
Emulation: EPL
Media: Continuous
Print Type: Direct thermal
Print density: 8
Label size: 90.0mm
Gap size: 2.0mm
Label AD: 750
Gap AD: 1700
AD Sensor: 50mA
Print speed: 5.0 IPS
Paper Sensor: Gap Sensor
Paper Sensor Adjust: 1Level
Peeler: Off
Cutter: Off
Print count: 439m
LCD Backlight: On
Calibrate Label: Off
Top Form Sensing: Off
Print Position: Off
Cut position: 0.0 mm
Horizontal pon:tion: 0.0 mm
Vertical position: 0.0 mm
Print width: 106mm(12dot/mm)
TearPOS Time: Off
Menu Lock: No
【Net Config】
IP Address: 192.168.000.007
IP Mode: DHCP
Subnet Mask : 255.255.255.000
Gateway: 192.168.000.001
IPv4 Speed: Auto Negotiation
MAC Address: BC:9D:A5:03:C0:43
***** Complete *****
```

## 4.2 Hex-dump

If the printer fails to print online but can print the configuration list offline, you may set the printer to operate in hex-dump mode to check the communication between the PC and the printer. Feedback any problem to our customer support with this hex-dump list.

The procedures to set the printer operating in hex-dump mode:

- Hold the ►► button when turn on the printer. Release this key after the power LED flashes 3 times and the buzzer beeps 3 time.

## 4.3 Auto Media Registration

If the media sensors are properly setup, the printer can detect and automatically register the media to proper position.

1. Ensure the media is loaded correctly.
2. After turn on the printer or lock the print head, the printer automatically carries the media registration processes.

## CHAPTER 5 DIAGNOSTICS AND MAINTENANCE

This printer is highly reliable. For precaution, this chapter recommends solutions to problems. In the meantime, we describe some guidelines to maintain the printer in good conditions.

Follow the safety guideline to prevent harms to the operators and the printer.

### 5.1 Diagnostics

This list provides recommended solutions to the problems. Consult the re-seller's customer support if faults persists.

Faults	Probable Causes	Recommended Solutions
No power light	<ul style="list-style-type: none"> <li>● Poor power connections</li> <li>● Broken power cord</li> <li>● Broken fuse</li> </ul>	<ul style="list-style-type: none"> <li>● Ensure secure connections from the printer socket to the wall socket.</li> <li>● Ensure to use power cord dedicated for this printer.</li> <li>● Check the switch box if the fuse is intact.</li> </ul>
No printout but normal media feeding	<ul style="list-style-type: none"> <li>● Dirty print head</li> <li>● Media stuck on the head</li> <li>● Improper ink ribbon</li> </ul>	<ul style="list-style-type: none"> <li>● Use supplied print head cleaning kit to clean the head.</li> <li>● Remove the blocking media from the head and clean the adhesive left on the head with a cloth soaked with alcohol . (<i>Using metallic tools to clear blocking media may damage the head.</i>)</li> <li>● Install genuine and correct type of ribbon for your media.</li> </ul>
Unclear printout	<ul style="list-style-type: none"> <li>● Mismatch media and ribbon parameters</li> <li>● Incorrect darkness</li> <li>● Dirty or deformed rollers</li> <li>● Media fall on the head</li> <li>● Improper ink ribbon</li> <li>● Improper media thickness</li> <li>● Unbalance head pressure across the media width</li> </ul>	<ul style="list-style-type: none"> <li>● Adjust different media/ribbon setting combinations.</li> <li>● Choose the proper density in the menu or driver settings.</li> <li>● Clean the rollers with alcohol. Replace them if deformed. (<i>Consult the re-seller to order parts.</i>)</li> <li>● Remove the blocking media from the head and clean the adhesive left on the head with a cloth soaked with alcohol . (<i>Using metallic tools to clear blocking media may damage the head.</i>)</li> <li>● Install genuine and correct type of ribbon for your media.</li> <li>● Turn the Media Thickness Dial for proper clearance between the head and the media.</li> <li>● Slide the Media Width Slider for proper head pressure.</li> </ul>
Print position shifted	<ul style="list-style-type: none"> <li>● Mismatch media and ribbon parameters</li> <li>● Dirty or deformed rollers</li> <li>● Incorrect codes and commands from the PC</li> <li>● Incorrect menu settings</li> <li>● Improper sensitivity for the media sensor</li> </ul>	<ul style="list-style-type: none"> <li>● Adjust different media/ribbon setting combinations..</li> <li>● Clean the rollers with alcohol. Replace them if deformed. (<i>Consult the re-seller to order parts.</i>)</li> <li>● If error message is displayed, check the software contents, the communication settings in the PC.</li> <li>● Use the operation panel or Config Tool to correct the settings.</li> <li>● Choose proper media sensor sensitivity. If the problem persists, change the sensor</li> </ul>

Faults	Probable Causes	Recommended Solutions
		sensitivity level in System Setup.
Winkled ribbon	<ul style="list-style-type: none"> <li>● Improper ribbon tension</li> <li>● Left/right tension of the ribbon not balanced</li> <li>● Incorrect darkness</li> <li>● Improper media and ink ribbon</li> </ul>	<ul style="list-style-type: none"> <li>● Turn the Ribbon Winding Knob to adjust the tension.</li> <li>● Turn the Ribbon Balance Dial.</li> <li>● Choose the proper density in the menu or driver settings.</li> <li>● Use genuine and correct type of supplies. (<i>Consult the re-seller for supplies.</i>)</li> </ul>
Slipping ribbon (dirts accumulate)	<ul style="list-style-type: none"> <li>● Improper ribbon tension</li> </ul>	<ul style="list-style-type: none"> <li>● Turn the Ribbon Winding Knob to adjust the tension.</li> </ul>
Jammed ribbon	<ul style="list-style-type: none"> <li>● Incorrect ribbon winding</li> <li>● Reversed ribbon</li> </ul>	<ul style="list-style-type: none"> <li>● Reload the ribbon correctly</li> <li>● Install the ribbon in the correct winding direction.</li> </ul>

## 5.2 Restore Factory Default Settings

Sometimes restoring factory default settings helps to resolve the problems. There are three ways to do it:

- When turn on the power, hold the ►► key until the power LED flashes 4 times and the buzzer beeps 4 times.
- Use the Configuration Tool to restore factory defaults.
- Use control panel to restore factory defaults.

## 5.3 Clear Jammed Media



Caution: Beware of high temperature near the print head.

- Turn off the power. Open the top cover. Unlock and lift the print head.
- Remove the media attached to the ribbon. Remove the ribbon. Use a cotton swab, soaked with alcohol to clean up the print head.
- Reload the media.
- Reload the ribbon. Turn the winding knob to get the affected portion of ribbon out of the way.

## 5.4 Clean the Print Head



Let the head cool down before cleaning.

Avoid damage to the head with finger nails or solid objects.

Turn off the power. Open the top cover and unload the ribbon. Clean the head with a cotton swab soaked with alcohol (alcohol, methanol, or isopropyl alcohol).

To get good print quality, clean the head once every 3 months.

## 5.5 Cleaning

This printer is toughly built to meet heavy load without regular maintenance. However regular cleaning can extend the operating life of the printer.

It is recommended to clean the printer every 6 months or 300 operating hours. Turn off the power and unplug the power cord before cleaning.

- Pick up paper debris by a pair of tweezers.
- Clean up the dust inside by a brush or compact vacuum cleaner.
- Clean up the dirt inside with a clean cloth.
- Clean the platen with a soft cloth.

Avoid damages to or loosing the cable winding and components inside. Avoid metallic objects falling into the electric areas to cause short-circuit.

## CHAPTER 6 INTERFACE SPECIFICATIONS

### 6.1 USB

USB Pin Assignment:

Pin	Signal Name	Color
1	VBUS	Red
2	D-	White
3	D+	Green
4	GND	Black

USB B Female Connector:

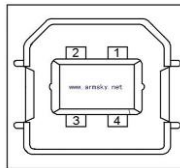

### 6.2 Ethernet

Pin Assignment

Pin	Signal Name	Description
1	TX+	Transmit Data+
2	TX-	Transmit Data-
3	RX+	Receive Data+
4	n/c	Not connected
5	n/c	Not connected
6	RX-	Receive Data-
7	n/c	Not connected
8	n/c	Not connected

RJ-45 Connector:

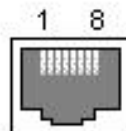

### 6.3 Parallel

Pin	Source	Signal Name
1	H	STROBE*
2	H	Data0 (LSB)
3	H	Data1
4	H	Data2
5	H	Data3
6	H	Data4
7	H	Data5
8	H	Data6
9	H	Data7 (MSB)
10	P	ACK*
11	P	BUSY
12	P	PError
13	—	Not Connected
14	—	Not Connected
15	—	Not Connected
16	Logic Ground	
17	Chassis Ground	
18	—	5V/500mA driver
19~30	Logic Ground	
31	—	INIT*
32	P	FAULT*
33	Logic Ground	
34~35	—	Not Connected
36	Not Connected	

Remarks: H - signal source from host; P - signal source from printer.

1284-B Connector:

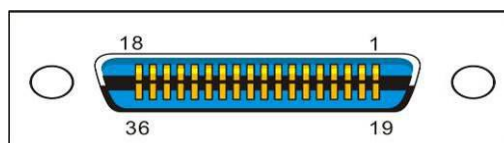

## 6.4 Serial

The serial interface of this printer is compatible with RS-232, using DB25 hole type socket.

Pin	Signal Name
PIN1	GROUND
PIN2	TXD
PIN 3	RXD
PIN 4	RTS
PIN 5	EMPTY
PIN 6	DSR
PIN 7	SIGNAL GROUND
PIN 8~19	EMPTY
PIN 20	DTR
PIN 21~25	EMPTY

The settings of serial interface can be checked by printing self-test page. The default baud rate is 38400bps, 8 data bit, no parity, and 1 stop bit. Handshaking protocol is DTR/DSR.

Serial interface connector

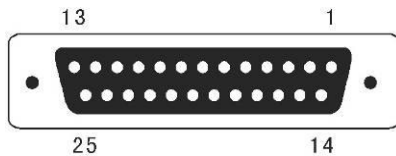



## 6.5 Wifi

Function description:

Network type – User to select.

STA- IP address will be obtained from the terminal network.

AP- IP address will be obtained from the printer, which is acted as WIFI access point.

Channel number – User defined. It can be selected according to the channel number of the router.

DHCP – User defined. IP address can be obtained dynamically.

Security mode – User defined. User can select the security mode according to WIFI mode and router encryption type.

Network name – User defined.

IP Address – User defined. If Static Address Method is selected, type in the address the printer will use on the network.

SubNetMask – User defined. If Static Address Method is selected, type in the subnet mark of the network.

GateWay – User defined. If Static Address Method is selected, type in the gateway address of the network.

WiFi Port – Default value = 9100

Specification:

	Item	Parameters
Wireless	Wireless Standard	IEEE802.11b/g/n
	Frequency Range	2.412~2.462 GHz
	Receiver Sensitivity	802.11b: -82 dBm @ 11Mbps (typical) 802.11g: -68 dBm @ 54Mbps (typical)
	Data Rate	802.11b: 1,2,5.5,11 Mbps
		802.11g: 6,9,12,18,24,36,48,54 Mbps
	Modulation	DSSS, OFDM, DBPSK, DQPSK, CCK, QAM16/64
	Antenna Interface	IPX/microstrip antenna

## CHAPTER 7 OPTION INTRODUCTION

### 7.1 Using the Cutter

Cutter is the factory option of the printer. Below is the front view of the printer configured with cutter.



- **Enable the cutter in the setup menu**

1. The printer originally works in Normal mode. Press  $\therefore$  button once to enter Setup mode. Press  $\blacksquare$  button once to scroll forward getting the System Setup menu.

```
Tally Dascom DL-830
System Setup <
Setup
```

2. Press  $\blacktriangleright\blacktriangleright$  button once to accept entering the System Setup menu. Keep pressing  $\blacksquare$  button to scroll to Cutter sub-menu. Press  $\blacktriangleright\blacktriangleright$  button once to accept entering Cutter setting. Press  $\blacksquare$  button once to scroll the value from Off to On.

```
Tally Dascom DL-830
Cutter <
Off
```

3. Press  $\blacktriangleright\blacktriangleright$  button to accept saving the value of On for Cutter. Press  $\therefore$  button twice to terminate Setup mode and return to Normal mode.

```
Tally Dascom DL-830
Print Ready
Setup
```

## 7.2 Using the Peeler

The Peeler is the factory-installed option for the Printer. Below is the front view of the printer configured with peeler.



- **Load continuous tag**

1. Load the continuous tag and press the switch on the swinging arm of the peeler to open it.

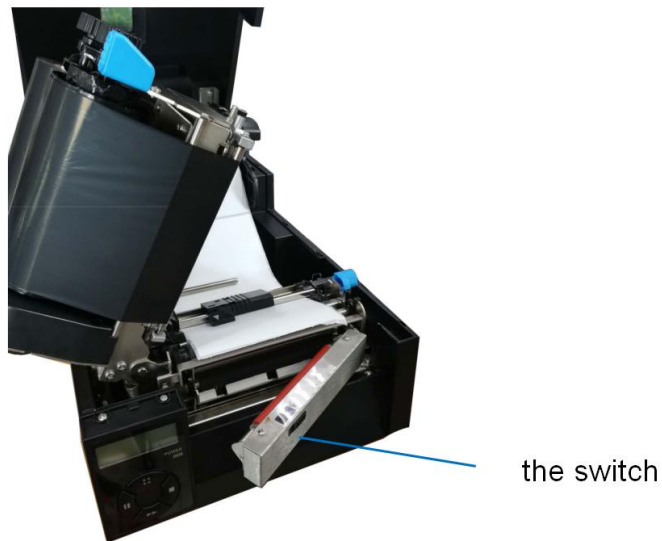

2. Pull out a piece of label paper and tear off the sticker, leaving the base paper.



3. Clamping the base paper without sticker with swinging arm. The base paper should be as straightening as possible to avoid paper jam.



4. Close the swinging arm and press down the release lever to lock the print head.



- **Enable the peeler in the setup menu**

1. The printer originally works in Normal mode. Press **⋮** button once to enter Setup mode. Press **■** button once to scroll forward getting the System Setup menu.



2. Press **▶▶** button once to accept entering the System Setup menu. Keep pressing **■** button to scroll to Peeler sub-menu. Press **▶▶** button once to accept entering Peeler setting. Press **■** button once to scroll the value from Off to On.

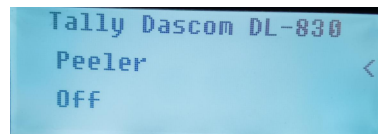

3. Press **▶▶** button to accept saving the value of On for Peeler. Press **⋮** button twice to terminate Setup mode and return to Normal mode.

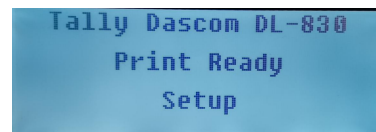



## CHAPTER 8 CODE PAGES

### 8.1 ASCII CHARACTER SET

HEX	0	1	2	3	4	5	6	7
0	NUL 00	DLE 16	SP 32	0 48	@ 64	P 80	` 96	p 112
1		XON 17	! 33	1 49	A 65	Q 81	a 97	q 113
2			" 34	2 50	B 66	R 82	b 98	R 114
3		XOFF 19	# 35	3 51	C 67	S 83	c 99	s 115
4	EOT 04	DC4 20	\$ 36	4 52	D 68	T 84	d 100	t 116
5	ENQ 05	NAK 21	% 37	5 53	E 69	U 85	e 101	u 117
6	ACK 06		& 38	6 54	F 70	V 86	f 102	V 118
7		CAN 23	' 39	7 55	G 71	W 87	g 103	w 119
8			( 40	8 56	H 72	X 88	h 104	x 120
9	HT 09		) 41	9 57	I 73	Y 89	i 105	y 121
A	LF 10		* 42	: 58	J 74	Z 90	j 106	Z 122
B		ESC 27	+ 43	; 59	K 75	[ 91	k 107	{ 123
C	FF 12	FS 28	, 44	< 60	L 76	\ 92	l 108	 124
D	CR 13	GS 29	- 45	= 61	M 77	] 93	m 109	} 125
E		RS 30	. 46	> 62	N 78	^ 94	n 110	~ 126
F			/ 47	? 63	O 79	_ 95	o 111	SP 127

## 8.2 CP 437 USA







HEX	8	9	A	B	C	D	E	F
0	Ç 128	É 144	á 160	 176	L 192	⋈ 208	α 224	≡ 240
1	ü 129	æ 145	í 161	 177	⊥ 193	⌣ 209	β 225	± 241
2	é 130	Æ 146	ó 162	 178	⊤ 194	⊘ 210	Γ 226	≥ 242
3	â 131	ô 147	ú 163	 179	⊢ 195	⋈ 211	π 227	≤ 243
4	ä 132	ö 148	ñ 164	⊣ 180	— 196	⋈ 212	Σ 228	∫ 244
5	à 133	ò 149	Ñ 165	⊣ 181	⊣ 197	F 213	σ 229	∫ 245
6	å 134	û 150	ä 166	⋈ 182	⊣ 198	π 214	μ 230	÷ 246
7	ç 135	ù 151	œ 167	π 183	⋈ 199	⋈ 215	τ 231	≈ 247
8	ê 136	ÿ 152	¿ 168	⊣ 184	⋈ 200	⊣ 216	Φ 232	° 248
9	ë 137	Ö 153	Γ 169	⋈ 185	⋈ 201	⋈ 217	Θ 233	• 249
A	è 138	Ü 154	¬ 170	⋈ 186	⋈ 202	Γ 218	Ω 234	· 250
B	ï 139	ø 155	½ 171	⋈ 187	⋈ 203	■ 219	δ 235	√ 251
C	î 140	£ 156	¼ 172	⋈ 188	⋈ 204	■ 220	∞ 236	n 252
D	ì 141	¥ 157	í 173	⋈ 189	= 205	■ 221	Φ 237	² 253
E	Ä 142	Pt 158	« 174	⋈ 190	⋈ 206	■ 222	ε 238	■ 254
F	Å 143	f 159	» 175	⋈ 191	⋈ 207	■ 223	∩ 239	SP 255



## 8.3 CP 850

HEX	8	9	A	B	C	D	E	F
0	Ç 128	É 144	á 160	☐ 176	Ł 192	ö 208	Ó 224	- 240
1	ù 129	æ 145	í 161	☐ 177	⊥ 193	Ð 209	β 225	± 241
2	é 130	Æ 146	ó 162	☐ 178	⊥ 194	Ê 210	Ô 226	= 242
3	â 131	ô 147	ú 163	 179	† 195	Ë 211	Ò 227	¾ 243
4	ä 132	ö 148	ñ 164	‡ 180	- 196	È 212	õ 228	¶ 244
5	à 133	ò 149	Ñ 165	Á 181	† 197	ı 213	Õ 229	§ 245
6	å 134	û 150	ä 166	Â 182	ã 198	í 214	μ 230	÷ 246
7	ç 135	ù 151	ø 167	À 183	Ã 199	î 215	þ 231	· 247
8	ê 136	ÿ 152	¿ 168	© 184	ℒ 200	ï 216	ƒ 232	° 248
9	ë 137	Ö 153	® 169	¶ 185	℞ 201	ƒ 217	Ú 233	ˆ 249
A	è 138	Ü 154	¬ 170	 186	ℒ 202	ƒ 218	Û 234	· 250
B	ï 139	ø 155	½ 171	¶ 187	℞ 203	■ 219	Ù 235	<sup>1</sup> 251
C	î 140	£ 156	¼ 172	¶ 188	℞ 204	■ 220	Ý 236	<sup>3</sup> 252
D	ì 141	Ø 157	ı 173	¢ 189	= 205	ı 221	Ý 237	<sup>2</sup> 253
E	Ä 142	× 158	« 174	¥ 190	¶ 206	ı 222	- 238	■ 254
F	Å 143	f 159	» 175	‡ 191	α 207	■ 223	' 239	SP 255



## 8.4 CP 860 Portuguese

HEX	8	9	A	B	C	D	E	F
0	Ç 128	É 144	á 160	 176	L 192	ll 208	α 224	≡ 240
1	ü 129	À 145	í 161	 177	l 193	fl 209	β 225	± 241
2	é 130	È 146	ó 162	 178	T 194	π 210	Γ 226	≥ 242
3	â 131	ô 147	ú 163	 179	l 195	ll 211	π 227	≤ 243
4	ã 132	õ 148	ñ 164	l 180	l 196	ll 212	Σ 228	 244
5	à 133	ò 149	Ñ 165	l 181	l 197	F 213	σ 229	 245
6	Á 134	Ú 150	ã 166	ll 182	fl 198	π 214	μ 230	÷ 246
7	ç 135	ù 151	œ 167	π 183	ll 199	fl 215	τ 231	≈ 247
8	ê 136	ì 152	ç 168	l 184	ll 200	fl 216	Φ 232	° 248
9	Ê 137	Õ 153	Ò 169	ll 185	fl 201	J 217	Θ 233	• 249
A	è 138	Ü 154	¬ 170	ll 186	ll 202	Γ 218	Ω 234	· 250
B	Í 139	ç 155	½ 171	ll 187	fl 203	 219	δ 235	√ 251
C	Ô 140	£ 156	¼ 172	ll 188	fl 204	 220	∞ 236	n 252
D	ì 141	Ù 157	í 173	ll 189	= 205	l 221	Φ 237	² 253
E	Ã 142	Pt 158	« 174	l 190	fl 206	l 222	ε 238	■ 254
F	À 143	Ó 159	» 175	l 191	ll 207	 223	∩ 239	SP 255



## 8.5 CP 863 French

HEX	8	9	A	B	C	D	E	F
0	Ç 128	É 144	Ì 160	⋮ 176	Ł 192	Ⓔ 208	α 224	≡ 240
1	Û 129	È 145	´ 161	⋮ 177	⊥ 193	⌞ 209	β 225	± 241
2	é 130	Ê 146	ó 162	⋮ 178	⊤ 194	⌠ 210	Γ 226	≥ 242
3	â 131	ô 147	ú 163	 179	⊢ 195	Ⓕ 211	Π 227	≤ 243
4	Â 132	Ë 148	¨ 164	⊣ 180	— 196	Ⓖ 212	Σ 228	∫ 244
5	à 133	Ï 149	˘ 165	⊤ 181	⊕ 197	Ⓕ 213	σ 229	∫ 245
6	¶ 134	û 150	³ 166	⌠ 182	⊣ 198	⌠ 214	μ 230	÷ 246
7	ç 135	ù 151	— 167	⌠ 183	⌠ 199	⌠ 215	τ 231	≈ 247
8	ê 136	α 152	î 168	⊣ 184	Ⓕ 200	⊣ 216	Φ 232	° 248
9	ë 137	Ô 153	⌠ 169	⌠ 185	Ⓕ 201	⌠ 217	Θ 233	• 249
A	è 138	Ü 154	¬ 170	⌠ 186	Ⓔ 202	⌠ 218	Ω 234	· 250
B	ï 139	ø 155	½ 171	⌠ 187	⌠ 203	■ 219	δ 235	√ 251
C	î 140	£ 156	¼ 172	⌠ 188	⌠ 204	■ 220	∞ 236	ⁿ 252
D	= 141	Ù 157	¾ 173	⌠ 189	= 205	■ 221	Φ 237	² 253
E	À 142	Û 158	« 174	⊣ 190	⌠ 206	■ 222	ε 238	■ 254
F	§ 143	f 159	» 175	⌠ 191	⊥ 207	■ 223	∩ 239	SP 255

## 8.6 CP 865 Nordic

HEX	8	9	A	B	C	D	E	F
0	Ç 128	É 144	á 160	 176	Ł 192	Ⓔ 208	α 224	≡ 240
1	ü 129	æ 145	í 161	 177	Ⓕ 193	Ⓕ̄ 209	β 225	± 241
2	é 130	Æ 146	ó 162	 178	Ⓖ 194	π 210	Γ 226	≥ 242
3	â 131	ô 147	ú 163	 179	Ⓕ̄ 195	Ⓔ 211	Π 227	≤ 243
4	ä 132	ö 148	ñ 164	Ⓕ̄ 180	— 196	Ⓔ 212	Σ 228	∫ 244
5	à 133	ò 149	Ñ 165	Ⓕ̄ 181	Ⓕ̄ 197	Ⓔ 213	σ 229	∫ 245
6	á 134	û 150	ä 166	Ⓕ̄ 182	Ⓔ 198	π 214	μ 230	÷ 246
7	ç 135	ù 151	ó 167	π 183	Ⓕ̄ 199	Ⓔ 215	τ 231	≈ 247
8	ê 136	ÿ 152	ı 168	Ⓕ̄ 184	Ⓔ 200	Ⓔ 216	Φ 232	° 248
9	ë 137	Ö 153	Ⓔ 169	Ⓕ̄ 185	Ⓔ 201	Ⓔ 217	Θ 233	• 249
A	è 138	Ü 154	Ⓕ̄ 170	Ⓕ̄ 186	Ⓔ 202	Ⓔ 218	Ω 234	• 250
B	ï 139	ø 155	½ 171	Ⓕ̄ 187	Ⓔ 203	■ 219	δ 235	√ 251
C	î 140	£ 156	¼ 172	Ⓕ̄ 188	Ⓔ 204	■ 220	∞ 236	n 252
D	ì 141	Ø 157	ı 173	Ⓕ̄ 189	= 205	■ 221	Φ 237	² 253
E	Ä 142	Pt 158	« 174	Ⓕ̄ 190	Ⓔ 206	■ 222	ε 238	■ 254
F	Å 143	f 159	Ⓕ̄ 175	Ⓕ̄ 191	Ⓔ 207	■ 223	∩ 239	SP 255

## 8.7 CP 858 European

HEX	8	9	A	B	C	D	E	F
0	Ç 128	É 144	á 160	 176	Ł 192	ö 208	Ó 224	- 240
1	ü 129	æ 145	í 161	 177	ł 193	Đ 209	β 225	± 241
2	é 130	Æ 146	ó 162	 178	Ṭ 194	Ê 210	Ô 226	= 242
3	â 131	ô 147	ú 163	 179	† 195	Ë 211	Ò 227	¾ 243
4	ä 132	ö 148	ñ 164	‡ 180	- 196	È 212	õ 228	¶ 244
5	à 133	ò 149	Ñ 165	Á 181	‡ 197	€ 213	Õ 229	§ 245
6	å 134	û 150	ä 166	Â 182	ã 198	í 214	μ 230	÷ 246
7	ç 135	ù 151	œ 167	À 183	Ã 199	î 215	þ 231	· 247
8	ê 136	ÿ 152	¿ 168	© 184	ℒ 200	ï 216	ƒ 232	° 248
9	ë 137	Ö 153	® 169	¶ 185	℞ 201	Ƶ 217	Ú 233	¨ 249
A	è 138	Ü 154	¬ 170	 186	≡ 202	Ɠ 218	Û 234	· 250
B	ï 139	ø 155	½ 171	¶ 187	≡ 203	■ 219	Ù 235	¹ 251
C	î 140	£ 156	¼ 172	¶ 188	≡ 204	■ 220	Ý 236	³ 252
D	ì 141	Ø 157	ì 173	¢ 189	= 205	¡ 221	Ý 237	² 253
E	Ä 142	× 158	« 174	¥ 190	≡ 206	ì 222	- 238	■ 254
F	Å 143	f 159	» 175	‡ 191	α 207	■ 223	' 239	SP 255

## 8.8 CP 866 Cyrillic

HEX	8	9	A	B	C	D	E	F
0	А 128	Р 144	а 160	▒ 176	Л 192	л 208	р 224	Ё 240
1	Б 129	С 145	б 161	▒ 177	л 193	т 209	с 225	ё 241
2	В 130	Т 146	в 162	▒ 178	т 194	т 210	т 226	Є 242
3	Г 131	У 147	г 163	 179	т 195	л 211	у 227	е 243
4	Д 132	Ф 148	д 164	┘ 180	— 196	л 212	ф 228	ї 244
5	Е 133	Х 149	е 165	┘ 181	┘ 197	т 213	х 229	і 245
6	Ж 134	Ц 150	ж 166	┘ 182	т 198	т 214	ц 230	ђ 246
7	З 135	Ч 151	з 167	т 183	т 199	т 215	ч 231	ђ 247
8	И 136	Ш 152	и 168	т 184	л 200	т 216	ш 232	° 248
9	Й 137	Щ 153	й 169	т 185	т 201	т 217	щ 233	• 249
A	К 138	Ъ 154	к 170	т 186	л 202	т 218	ъ 234	· 250
B	Л 139	Ы 155	л 171	т 187	т 203	▀ 219	ы 235	√ 251
C	М 140	Ь 156	м 172	л 188	т 204	▀ 220	ь 236	№ 252
D	Н 141	Э 157	н 173	л 189	= 205	▀ 221	э 237	¤ 253
E	О 142	Ю 158	о 174	т 190	т 206	▀ 222	ю 238	■ 254
F	П 143	Я 159	п 175	т 191	л 207	▀ 223	я 239	SP 255

## 8.9 CP 852 Latin

HEX	8	9	A	B	C	D	E	F
0	Ç 128	É 144	á 160	⋯ 176	Ł 192	đ 208	Ó 224	- 240
1	ü 129	Í 145	í 161	⋮ 177	Ł 193	Đ 209	β 225	“ 241
2	é 130	Í 146	ó 162	⋮ 178	Т 194	Ǧ 210	Ô 226	‘ 242
3	â 131	ô 147	ú 163	 179	† 195	Ě 211	Ń 227	˘ 243
4	ä 132	ö 148	Ą 164	‡ 180	– 196	ď 212	ń 228	˘ 244
5	ű 133	Ĺ 149	ą 165	Á 181	† 197	Ň 213	ň 229	§ 245
6	ć 134	Ĳ 150	ż 166	Â 182	Ǻ 198	í 214	š 230	÷ 246
7	ç 135	Ś 151	ż 167	Ě 183	ǻ 199	î 215	š 231	˘ 247
8	ł 136	ś 152	Ę 168	Ş 184	Ł 200	ě 216	Ŕ 232	° 248
9	ë 137	Ö 153	ę 169	 185	Ɔ 201	Ј 217	Ú 233	¨ 249
A	Ő 138	Ü 154	SP 170	 186	Ł 202	Г 218	ř 234	• 250
B	ő 139	Ť 155	ż 171	 187	Ɔ 203	■ 219	Ů 235	ů 251
C	î 140	ť 156	č 172	 188	Ɔ 204	■ 220	ý 236	ř 252
D	ž 141	ł 157	ş 173	Ž 189	= 205	Т 221	Ý 237	ř 253
E	Ä 142	× 158	« 174	ž 190	 206	Ů 222	ţ 238	■ 254
F	Ć 143	č 159	» 175	Г 191	α 207	■ 223	’ 239	SP 255

## 8.10 CP 720 Arabic

HEX	8	9	A	B	C	D	E	F
0	SP 128	SP 144	ب 160	ب 176	ل 192	لا 208	ض 224	≡ 240
1	SP 129	س 145	ة 161	ب 177	ل 193	ف 209	ط 225	≈ 241
2	é 130	و 146	ت 162	ب 178	ت 194	ن 210	ظ 226	≈ 242
3	a 131	ò 147	ث 163	 179	ت 195	لا 211	ع 227	≈ 243
4	SP 132	م 148	ج 164	ت 180	- 196	ط 212	غ 228	≈ 244
5	à 133	- 149	ح 165	ف 181	ت 197	ف 213	ف 229	≈ 245
6	SP 134	ù 150	خ 166	ف 182	ف 198	ن 214	م 230	≈ 246
7	ç 135	ù 151	د 167	ن 183	ف 199	ف 215	ق 231	≈ 247
8	ê 136	ء 152	ذ 168	ف 184	لا 200	ف 216	ك 232	° 248
9	ë 137	أ 153	ر 169	ف 185	ن 201	ل 217	ل 233	° 249
A	è 138	أ 154	ز 170	ف 186	لا 202	ر 218	م 234	° 250
B	ï 139	ؤ 155	س 171	ف 187	ن 203	■ 219	ن 235	√ 251
C	î 140	£ 156	ش 172	ك 188	ف 204	■ 220	ه 236	n 252
D	SP 141	إ 157	ص 173	لا 189	ف 205	■ 221	و 237	2 253
E	SP 142	ئا 158	« 174	ك 190	ف 206	■ 222	ي 238	■ 254
F	SP 143	ا 159	» 175	ك 191	SP 207	■ 223	ي 239	SP 255



## CHAPTER 9 COMMAND CODES

### 9.1 ZPL Command Set

Code	Description
^A	Scalable/Bitmapped Font
^A@	Use Font Name to Call Font
^B0	Aztec Bar Code Parameters
^B1	Code 11 Bar Code
^B2	Interleaved 2 of 5 Bar Code
^B3	Code 39 Bar Code
^B4	Code 49 Bar Code
^B5	Planet Code bar code
^B7	PDF417 Bar Code
^B8	EAN-8 Bar Code
^B9	UPC-E Bar Code
^BA	Code 93 Bar Code
^BB	CODABLOCK Bar Code
^BC	Code 128 Bar Code (Subsets A, B, and C)
^BD	UPS MaxiCode Bar Code
^BE	EAN-13 Bar Code
^BF	MicroPDF417 Bar Code
^BI	Industrial 2 of 5 Bar Codes
^BJ	Standard 2 of 5 Bar Code
^BK	ANSI Codabar Bar Code
^BL	LOGMARS Bar Code
^BM	MSI Bar Code
^BO	Aztec Bar Code Parameters
^BP	Plessey Bar Code
^BQ	QR Code Bar Code
^BR	GS1 Databar (formerly Reduced Space Symbology)
^BS	UPC/EAN Extensions
^BT	TLC39 Bar Code
^BU	UPC-A Bar Code
^BX	Data Matrix Bar Code
^BY	Bar Code Field Default
^CC ~CC	Change Caret

Code	Description
^BZ	POSTAL Bar Code
^CD	~CD Change Delimiter
^CF	Change Alphanumeric Default Font
^CI	Change International Font/Encoding
^CM	Change Memory Letter Designation
^CO	Cache On
^CP	Remove Label
^CV	Code Validation
^CW	Font Identifier
~DB	Download Bitmap Font
~DE	Download Encoding
^DF	Download Format
~DG	Download Graphics
~DN	Abort Download Graphic
~DS	Download Intellifont (Scalable Font)
~DT	Download Bounded TrueType Font
~DU	Download Unbounded TrueType Font
~DY	Download Objects
~EG	Erase Download Graphics
^FB	Field Block
^FC	Field Clock
^FD	Field Data
^FH	Field Hexadecimal Indicator
^FL	Font Linking
^FM	Multiple Field Origin Locations
^FN	Field Number
^FO	Field Origin
^FP	Field Parameter
^FR	Field Reverse Print
^FS	Field Separator
^FT	Field Typeset
^FV	Field Variable
^FW	Field Orientation
^MD	Media Darkness

Code	Description
^MF	Media Feed
^ML	Maximum Label Length
^MM	Print Mode
^MN	Media Tracking
^MP	Mode Protection
^MT	Media Type
^MU	Set Units of Measurement
^MW	Modify Head Cold Warning
^NC	Select the Primary Network Device
~NC	Network Connect
^ND	Change Network Settings
^NI	Network ID Number
~NR	Set All Network Printers Transparent
^NS	Change Wired Networking Settings
~NT	Set Currently Connected Printer Transparent
^PA	Advanced Text Properties
^PF	Slew Given Number of Dot Rows
^PH ~PH	Slew to Home Position
~PL	Present Length Addition
^PM	Printing Mirror Image of Label
^PN	Present Now
^PO	Print Orientation
^PP ~PP	Programmable Pause
^PQ	Print Quantity
^PR	Print Rate
~PR	Applicator Reprint
~PS	Print Start
^PW	Print Width
~RO	Reset Advanced Counters
^SC	Set Serial Communications
~SD	Set Darkness
^SE	Select Encoding Table
^SF	Serialization Field (with a Standard ^FD String)
^SI	Set Sensor Intensity

---

---

Code	Description
^SN	Serialization Data
^SP	Start Print
^SQ	Halt ZebraNet Alert
^SR	Set Printhead Resistance
^SS	Set Media Sensors
^SZ	Set ZPL
^TB	Text Blocks
^TO	Transfer Object
~WC	Print Configuration Label
^WD	Print Directory Label
~WQ	Write Query
~WQ	Examples
^XA	Start Format
^XB	Suppress Backfeed
^XF	Recall Format
^XG	Recall Graphic
^XS	Set Dynamic Media Calibration
^XZ	End Format
^ZZ	Printer Sleep

## 9.2 EPL Command Set

Code	Description
A	ASCII text
B	1D (EAN-8 / EAN-13 / UPC-A / Interleaved 25 / Codabar / UPC-E / Code39 / Code 128)
b	2D (Data Matrix / PDF417 / QR Code)
C	Cut immediate
D	Density
EI	Print soft font information
EK	Delete soft font
ES	Store soft font
f	Cut position
GG	Print graphics
GI	Print graphics information
GK	Delete graphics
GM	Store graphics
I	Select character set
JF	Enable top of form backup
LO	Line draw black
LS	Line Draw diagonal
N	Clear image buffer
O	Hardware options
P	Print
q	Set label width
Q	Set form length
R	Set reference point
S	Select speed
X	Draw box
Z	Print direction
:	Code comment line
^@	Reset
^default	Restore factory default

### 9.3 TSPL Command Set

Commands	Description
SIZE	This command defines the label width and length.
BLINE	This command sets the height of the black line and the user-defined extra label feeding length each form feed takes.
BARCODE	This command prints 1D barcodes.
QRCODE	This command prints QR code.
GAP	Defines the gap distance between two labels.
REFERENCE	This command defines the reference point of the label.
SPEED	This command defines the print speed.
DENSITY	This command sets the printing darkness.
SET PEEL	This setting is used to enable/disable the self-peeling function. The default setting for this function is off.
SET CUTTER	This setting activates or deactivates the cutter and defines how many printed labels is to be cut at one time.
SET PARTIAL_CUTTER	This setting activates or deactivates the cutter and defines how many printed labels is to be cut at one time.
SET TEAR	This command is used to enable/disable feeding of labels to gap/black mark position for tearing off.
SET RIBBON	This setting is used to enable/disable ribbon sensor detection.
DIRECTION	This command defines the printout direction.
SHIFT	This command moves the label's vertical position.
OFFSET	This command defines the selective, extra label feeding length each form feed takes, which, especially in peel-off mode and cutter mode, is used to adjust label stop position, so as for label to register at proper places for the intended purposes. The printer back tracks the extra feeding length before the next run of printing.
BITMAP	This command draws bitmap images.
REVERSE	This command reverses a region in image buffer.
CLS	This command clears the image buffer.
PRINT	This command prints the label format currently stored in the image buffer.
PUTPCX	This command prints PCX format images.

KILL	This command deletes a file in the printer memory.
DOWNLOAD	“DOWNLOAD” is a header of the file that is to be saved in the printer’s memory.

## **FCC STATEMENT**

Changes or modifications not expressly approved by the responsible for compliance could void the user's authority to operate the equipment.

NOTE: This equipment has been tested and found to comply with the limits for a class B digital device, pursuant to Part 15 of the FCC Rules. These limits are designed to provide reasonable against harmful interference in a residential installation. This equipment generates, uses and can radiate radio frequency energy and, if not installed and used in accordance with the instructions, may cause harmful interference to radio communications. However, there is no guarantee that interference will not occur in a particular installation. If this equipment does cause harmful interference to radio or television reception, which can be determined by turning the equipment off and on, the user is encouraged to try to correct the interference by one or more of the following measures:

Reorient or relocate the receiving antenna.

Increase the separation between the equipment and receiver.

Connect the equipment into an outlet on a circuit different from that to which the receiver is connected.

Consult the dealer or an experienced radio/TV technician for help.

This device complies with Part 15 of the FCC Rules. Operation is subject to the following two conditions:

(1) This device may not cause harmful interference, and

(2) This device must accept any interference received, including interference that may cause undesired operation.

### **FCC Radiation Exposure Statement**

This equipment complies with FCC radiation exposure limits set forth for an uncontrolled environment.

This equipment should be installed and operated with minimum distance 20cm between the radiator & your body.



# DASCOM REPRESENTATIVES

## GERMANY

DASCOM Europe GmbH  
Heuweg 3  
89079 Ulm  
Germany  
Tel.: +49 (0) 731 2075 0  
Fax: +49 (0) 731 2075 100  
[www.dascom.com](http://www.dascom.com)

## SINGAPORE (ASIA PACIFIC)

DASCOM AP Pte Ltd  
2 Jurong East Street 21  
# 05-42, IMM Building  
Singapore 609601  
Phone: +65 6760 8833  
Fax: +65 6760 1066  
[www.dascom.com](http://www.dascom.com)

## FRANCE

DASCOM Europe GmbH  
117 Avenue Victor Hugo  
92100 Boulogne-Billancourt  
France  
Phone: +33 (1) 73 02 51 98  
[www.dascom.com](http://www.dascom.com)

## UNITED KINGDOM

DASCOM GB Ltd  
Hart House, Priestley Road,  
Basingstoke, Hampshire  
RG24 9PU, England  
Phone: +44 (0) 1256 355130  
Fax: +44 (0) 1256 481400  
[www.dascom.com](http://www.dascom.com)

## AMERICAS

Dascom Americas Corporation  
34 Lakeview Court  
Verona, VA 24482  
USA  
Phone: +1 (877) 434 1377  
Fax: +1 (877) 334 0549  
[www.dascom.com](http://www.dascom.com)

## CHINA

JIANGMEN DASCOM COMPUTER  
PERIPHERALS CO., LTD  
No.399, jinxing Road,  
Jianghai District Jiangmen,  
P.R. China  
[www.dascom.com](http://www.dascom.com)

"All rights reserved. Translations, reprinting or copying by any means of this manual complete or in part or in any different form requires our explicit approval. We reserve the right to make changes to this manual without notice. All care has been taken to ensure accuracy of information contained in this manual. However, we cannot accept responsibility for any errors or damages resulting from errors or inaccuracies of information herein."